

eZtrend[®] QXe X Series Advanced Graphic Recorder Specifications

43-TV-03-12, February 2013



Crystal Clear Display

- 5.5" Digital Colour LCD (TFT)
- QVGA Resolution (320 x 240 pixels)
- Clear and intuitive operation
- Industrial rugged Touch Screen with rapid navigation

Comprehensive Connectivity

- 10/100 Ethernet (DHCP), OPC Server Web and E-mail
- FTP and TCP/IP
- Modbus Master and Slave (option)
- RS485 Modbus Protocol (option)
- Front USB port as standard for keyboard and mouse. Rear USB option.

Data Storage

- On-board non-volatile memory - up to 400MB
- Removable USB storage
- No moving parts - all solid state Flash memory

Security Stringent - Total Data integrity

- Password Protection - 21CFR Part 11
- ESS - Extended Security System
- Password Network Synchronisation



Plus..

- Health Watch for preventative maintenance
- Remote Access - Advanced Software Data Analysis at your PC and Remote Viewing
- Independent Chart and Logging speeds
- Global Language Support
- Rapid review and replay of data at recorder
- Approvals - CE, CSA, UL & NEMA 4X/IP66 (option)
- Up to 10Hz (100 msec) Logging (including expansion card option)
- Up to 12 Analogue Inputs
- 4 Pulse Inputs via the Digital I/O card (option)
- Reports - System generated
- Concurrent Batch mode
- AMS2750 Process Capabilities

Recorder Function

- Honeywell's eZtrend QXe recorder provides flexible electronic data acquisition and recording in a DIN standard 144mm format recorder.
- Up to 12 Analogue inputs with at least 70MB standard on-board memory plus additional removable storage media.
- The eZtrend QXe uses a digital colour TFT LCD screen to provide easy to read displays with wide viewing angles for the best all around data viewing.
- The touch screen operator interface provides fast, easy access to the recorder menus making set up and data analysis quick and efficient. Navigation through the menus and text entry are direct and intuitive.

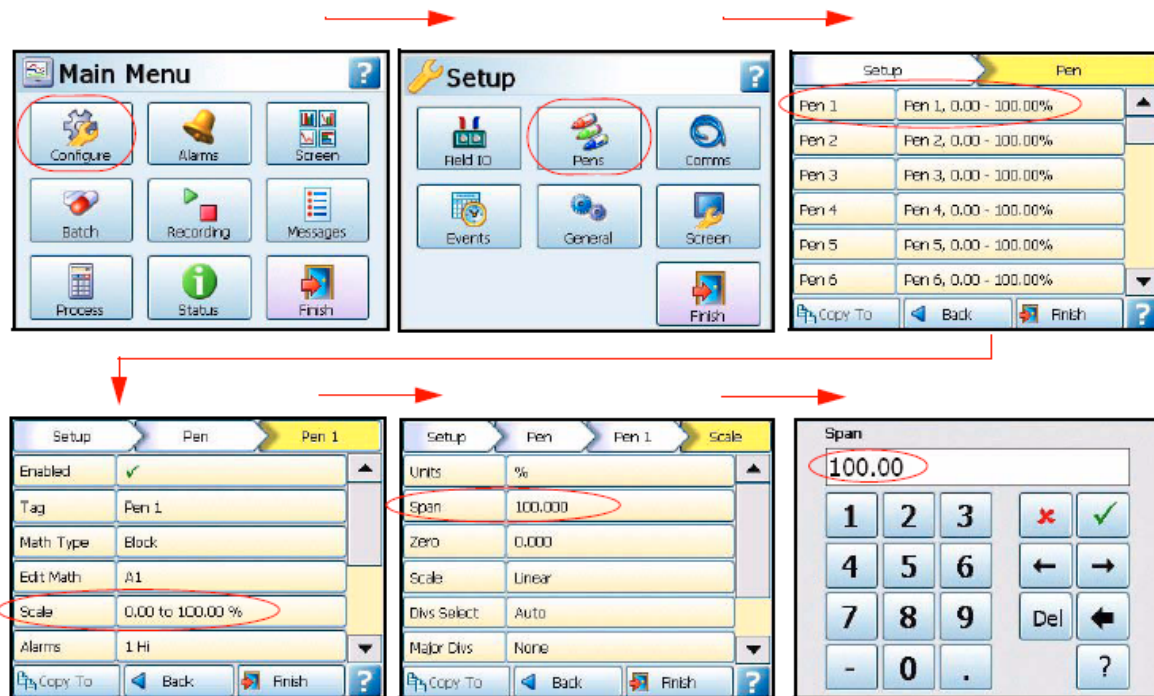

Example of a recorder menu path from the Main Menu to Pen Scale configuration with clear and rapid navigation

Features

Display

- **5.5" Colour Active TFT** - with more than 256,000 colours makes it easy to interpret process data and take action with the intuitive bar charts, digital values or trends displays. A screen saver function can be set from 1 to 720 minutes to extend the life of the backlight.
- **Touch Screen** - the heavy duty durable touch screen provides easy data entry and rapid navigation through the menus.
- **Help Files** - A complete contextual help system can be accessed and visualised on the screen of the recorder.

Communications

- **Ethernet Connectivity** - the Ethernet (DHCP standard) connection, with support for various protocols, provides unlimited connectivity to local area networks (LANs). The standard Ethernet interface makes networking of the recorder to a LAN or the world wide web fast and convenient. Dynamic Host Configuration Protocol (DHCP) automatically acquires the settings (IP address) for network communications from a DHCP server.
- **Simple Network Time Protocol (SNTP)** - The recorder can be synchronised over the ethernet network via a SNTP client or synchronise other recorders via a Server.
- **Web Server** - with the recorder connected to a LAN, all process variables, alarm and messages can be viewed from an internet browser; values are automatically refreshed.

Data Storage

Internal Data Storage - 70MB to 400MB of expandable internal non-volatile flash memory is available for data storage and chart history.

Example: Internal memory / Logging rate = 1 sec		
Pens	70MB	400MB
6	32days	182d
12	16d	91d
24	8d	45d

Data Export - Removable USB flash storage device.

Data is stored in a secure binary encrypted format, with the recorder's configurations, providing added security of the data files.

Removable USB flash storage devices



External USB Devices

The recorder has two USB host ports, one at the front (standard) and one at the rear available on the Communications card (option). This is for attaching external USB devices such as a keyboard, mouse or a USB data storage key. The keyboard and mouse can be used to navigate the recorder's screen and enter text.

Remote Viewer

Extends the user interface of the recorder onto the desktop PC. Providing remote viewing of the unit launched from a web browser. Full remote control is available as an option. Compatible with Microsoft™ Internet explorer 6 and higher.

Security

- **Total Data Integrity** - data is stored in secure encrypted files making it easy to retrieve the data dependent on process information. Data is automatically recognized without having to remember file names.
- **Password Protection** - Up to 4 levels of password protection with up to 50 different users are available. Multiple levels of password protection and an audit trail of actions enhance the security of the data.
- **Extended Security System (option)** - ESS provides extended features including entry of unique User ID's and associated passwords, time-out of password entry, password expiration, and traceability of user actions. ESS is compatible with the requirements of 21CFR part 11.
- **Password Network Synchronisation** - Password can be synchronised over the network, a recorder can be designated as a master of a password group and other recorders can be added to that group as slaves, the master will ensure all passwords are synchronised with all recorders in it's group.

Modbus Master/Slave

The recorder can communicate with up to 32 slave devices on both RS485 and/or Ethernet at a maximum poll rate of 1 second (slowest 1 hour), with each slave up to 8 “transactions” can be performed where a transaction can be retrieving 1 or more registers from a slave or sending one or more Pens to a slave.

Reports

Reports can be generated manually or on a periodical basis using event system to show daily/weekly/monthly totals, max mins, averages etc., the reports can be printed, e-mailed as attachments or exported to external media. The reports will be in RTF format for use in MS Word or other compatible word processors.

Events/Counters (option)

Certain conditions or operations can be set up and logged according to the time and date of the occurrence. Subsequently events can be reviewed in a list or represented on a graph. Up to 16 User Counters are available and can be used as a part of the Events system. User Counters can be set up as a Cause or an Effect of an Event. Preset Markers can be configured and used when applying a Mark to the chart through the event system, the alert system or manually.

Concurrent Batch Mode (option)

Batch enhances the management of data collected in non-continuous process, known as batch processing, used in thermal treatment, sterilisation, food processing and chemical reactions. Batch mode has changed to allow concurrent batches, where each batch is associated with a group, so all pens within Group 1 will belong to the batch that is controlled by Group 1. Batch features include Pause chart when batch stopped, Batch Logging control, List driven data fields, Automated batch counters, Event driven batch control, Updated control and feedback, Batch mode State and Count inscripts/embedded variables.

AMS2750 Process Mode (option)

Provides on-line monitoring in the process recorder to alert the user to potential AMS2750 non-compliance issues. Monitors and alerts the user concerning - days until next SAT, days until next TUS, days until next control T/C change out and days until the recorder requires calibration. The recorder also provides an overview of T/C usage for all survey T/C's providing a colour coded for early warning screen (5 day expiration).

Standard features

- **CE Mark** - Conformity with 73/23/EEC, Low Voltage Directive and 89/336/EEC EMC Directive.
- **Soft Alarms** - 6 "software" alarms per pen are easily set up to display and record selected out-of-limit conditions. These can be tied to the relay or digital outputs to activate the user's external equipment.
- **Communications** - the recorder supports FTP, Modbus TCP/IP (slave mode), web and email over Ethernet (DHCP standard) communications port and Modbus RTU (slave mode) via an RS485 port (option). USB ports allow the use of an ASCII barcode reader. Email sent to your network connected PC triggered by an Alarm or an Event.
- **Independent Display Chart Speeds and Logging rates** - logging rates can be programmed completely separate from the chart display speed, allowing the data to be displayed and stored at the rates that best suits the application.
- **Logarithmic Scales** - all displayed scales can be set as linear or logarithmic.
- **Enclosure rating** - standard NEMA 3 / IP54 type front face protection. NEMA 4X / IP66 available as an option.
- **Pulse Inputs** - The 8 Digital I/O option card has 4 channels that can be set as pulse inputs (first 4 channels). The operating frequency for pulse inputs on the Digital I/O card is 1kHz max.
- **Rate up and rate down alarms** - Users can configure a rate of change in engineering units to be checked over a time period in seconds from 1 to 3600 (1 hour).
- **Fuzzy Logging** - this standard feature provides a unique method to increase the storage capacity of the recorder. The data is monitored to determine changes in process data; if no changes are observed data is logged periodically. If data is changing rapidly, it is recorded normally at the programmed rate. By not logging data that is static, data compression of up to 100:1 or more can be achieved saving valuable memory.
- **Language Support** - standard language prompts for English UK & US, French, German, Italian, Spanish, Brazilian, Polish, Hungarian, Slovakian, Czech, Turkish, Romanian, Russian, Portuguese, Greek, Chinese, Japanese, Korean and Bulgarian.
- **Security tag** - "wire seal provision" that provides added security to seal the front door and rear wiring when using optional rear cover to prevent undetected entry to these areas of the recorder.
- **USB Ports** - Front and rear USB host ports for data and setup transfers or remote screen through this port. Front USB port is standard and the rear USB port is available with the Communications card option. Use these ports to attach external devices (keyboard or mouse), for direct interfacing with the recorder.
- **Replay with Zoom** - Select replay mode and zoom-in on a specific area on the screen. The data can easily be replayed at the recorder with the ability to "zoom". The touch screen makes it fast to review and analyse historical data. A "jump" function allows you to go from any message list directly to the trend showing the occurrence of the alarm.
- **Dual Cursors in Replay** - Displays the time and date between two independently positioned cursors on a replay screen. Also provides digital readings and shows the max min between the cursors.
- **Alert System** - Error messages can be displayed for serious errors such as a connectivity problems or can be used as an early warning message system to notify the user on potential memory storage space availability.
- **Sound Effects** - Sound effects, Used as an event effect the user can pick from a list of 20 different sounds these can be configured to play a single time or repeat continuously until a corresponding "stop" event is triggered for that sound. The sounds themselves can be replaced on the recorder with custom sounds.
- **User Variables** - Provides the user with the ability to set values for up to 32 variables that can be used in the maths and scripts. Values can be altered to effect calculations without having to change the configuration. User variables are non-volatile.

Options – Hardware

- **Alarm Card** - 4 or 8 outputs relay contacts SPCO 240V, 8 Digital I/O - SPNO 24VDC. Programmable alarm set points can be configured to activate up to 8 outputs.
- **RS485 Modbus** - the RS485 connection allows process data to be transferred to other devices, or to record data received in MODBUS RTU protocol (slave mode only).
- **Portable Recorders** - Portable cases available as an accessory item.
- **Approvals** - CSA and UL
- **Digital Input** - Two digital input options are available: 2 inputs on 8 channel Alarm card, 8 inputs on Digital I/O card. The digital inputs allow users to initiate, from a remote location via a dry contact closure, selected recorder functions.
- **24VAC/DC Power Supply** - 20 to 30VDC / 20 to 25VAC
- **24VDC Transmitter Power Supply** - can supply up to 130mA to external transmitters.
- **Print Support** - Network printing from status, message and replay screens. Plus screen capture facility of process screens instantly using a basic USB standard PCL printer.

eZtrend QXe Standard Screens

Up to 10 screens displaying multiple combinations of Charts, Bars and Digitals can be configured, 6 examples below.

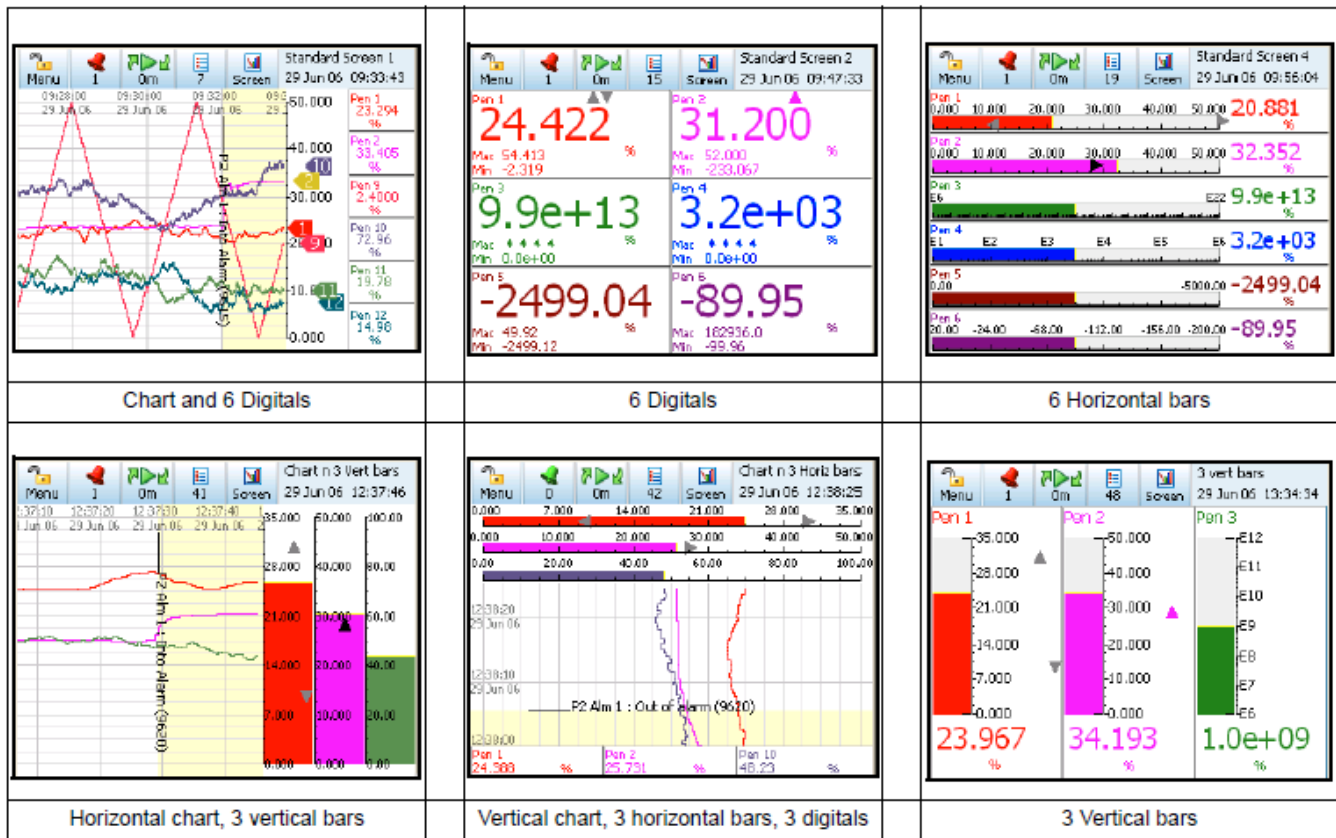

Firmware Credit System

The credits system is a flexible way of adding to the recorder features without having to upgrade the firmware. Simply purchase a number of credits to cover your current and possible future requirements and the recorder will be delivered with the credits loaded.

Credits can be applied as desired to the Firmware functions until the total number of credits purchased has been used up. Additional credits can be purchased later if new features are to be activated and not enough credits are available to support these additional functions.

Firmware options are selected using the Model Selection Guide. Details of each firmware option are listed here.

Firmware option	Credit value	Description
Full Maths	4	Full (Block) Math - this can handle math expressions that can consist of expressions up to 100-characters in length. (Note 1)
Totalisers/ Sterilisation calculation	4	Each pen can be associated with a totaliser. Using extra pens, the totalised values can be displayed and recorded; multiple totals can be calculated out of the same variable (weekly, monthly, etc.). The totaliser function can handle Fo and Po sterilisation calculation. (Note 1)
Reports	3	Generate reports manually or using the event system to show daily/weekly/monthly Totals, Max/ Mins, Averages, Current Value. Messages, Message Lists - Alarm, System, Diagnostic, Security & User, Counters, Digital Inputs, and Digital Outputs. Reports can be printed, e-mailed as an attachment or exported to external media in RTF format. Also batch report format to support batch operation.
Health Watch/ Maintenance	2	The recorder keeps track of important "life actions" for improved diagnostics and preventative maintenance notification. Including Powered On, Last powered On, Time On since power up, Total On time, Total Off time, Longest Off time, Lithium cell life, Backlight life left at 100% brightness, Compact Flash insertions, Hi/Lo CJC value (Hi & Lo temps), Analogue In last factory/user cal, Relay operations.
Print Support	2	Network printing from status, message and replay screens. Pluse screen capture facility of process screens instantly using a basic USB standard PCL printer.
Batch/Groups	5	The Batch function allows the user to segment portions of data for further analysis. The Batch function manages sections of data. Concurrent batches are now associated with a group of pens. The pens with in each group will belong to the batch that is controlled by that group. Batches can be controlled through the event system and batch markers are setup by the user and are used to identify and analyse batches of data. Supports up to 6 concurrent batches.
Counters	3	User Counters can be set up and used as a part of the Events system to count an occurrence. Other counters are available depending on hardware availability. Eg. Alarm, Event, Digital Input, Relay Output and Pulse counters.
Modbus Master	10	Modbus master enables the recorder to communicate with up to 32 Slave devices on both Ethernet and RS485. The recorder itself can also act as a slave device while also being a master. Mod-bus master can also be used in conjunction with OPC to enable the recorder to act as a communication bridge.

Firmware option	Credit value	Description		
Events	6	<p>Events are certain conditions or operations that can be set up and logged according to the time and date of an occurrence. Subsequently events can be reviewed or displayed on a graph.</p> <table border="0" data-bbox="472 331 1474 1144"> <tr> <td data-bbox="472 331 1032 1144"> <p>The Event Causes include:</p> <p>Alarms - Into/Out of and Alarm Ack Totals - Start/Stop/Reset/Reset and Start Digital Input - ON/OFF/State Change T/C Burnout Scheduled - Once/Interval/Specific Days/ Month End User Counters Max/Mins - Reset System - Power ON/Setup Change/ Internal Memory Low/Export Memory Low/ FTP Memory Low User Action - Mark Chart, Batch - Start/Stop/Pause. TUS - Start/Stop AMS2750 Timer -TC Timers/Process Timers</p> <p>Each event marker can be recorded for analysis using the Trend Manager Analysis Software Suite. (Note 2)</p> </td> <td data-bbox="1032 331 1474 1144"> <p>The Event Effects include:</p> <p>Mark Chart - User Defined/Preset Logging - Start/Stop Totaliser - Start/Stop/Reset/Reset & Start, Digital Output - ON/OFF Alarm Acknowledge Emails, Screen Change, Print Screen, Counters - Reset/Increment Max/Min (Reset) Chart Control- Pause/Stop/Resume/Clear/Prefil Clear All Messages, Delayed Event Script Timers - Start/Stop/Reset/Reset & Start Play Sound - Start/Stop Display Alert, Reports Batch - Start/Stop/Pause Update Tabular Readings</p> </td> </tr> </table>	<p>The Event Causes include:</p> <p>Alarms - Into/Out of and Alarm Ack Totals - Start/Stop/Reset/Reset and Start Digital Input - ON/OFF/State Change T/C Burnout Scheduled - Once/Interval/Specific Days/ Month End User Counters Max/Mins - Reset System - Power ON/Setup Change/ Internal Memory Low/Export Memory Low/ FTP Memory Low User Action - Mark Chart, Batch - Start/Stop/Pause. TUS - Start/Stop AMS2750 Timer -TC Timers/Process Timers</p> <p>Each event marker can be recorded for analysis using the Trend Manager Analysis Software Suite. (Note 2)</p>	<p>The Event Effects include:</p> <p>Mark Chart - User Defined/Preset Logging - Start/Stop Totaliser - Start/Stop/Reset/Reset & Start, Digital Output - ON/OFF Alarm Acknowledge Emails, Screen Change, Print Screen, Counters - Reset/Increment Max/Min (Reset) Chart Control- Pause/Stop/Resume/Clear/Prefil Clear All Messages, Delayed Event Script Timers - Start/Stop/Reset/Reset & Start Play Sound - Start/Stop Display Alert, Reports Batch - Start/Stop/Pause Update Tabular Readings</p>
<p>The Event Causes include:</p> <p>Alarms - Into/Out of and Alarm Ack Totals - Start/Stop/Reset/Reset and Start Digital Input - ON/OFF/State Change T/C Burnout Scheduled - Once/Interval/Specific Days/ Month End User Counters Max/Mins - Reset System - Power ON/Setup Change/ Internal Memory Low/Export Memory Low/ FTP Memory Low User Action - Mark Chart, Batch - Start/Stop/Pause. TUS - Start/Stop AMS2750 Timer -TC Timers/Process Timers</p> <p>Each event marker can be recorded for analysis using the Trend Manager Analysis Software Suite. (Note 2)</p>	<p>The Event Effects include:</p> <p>Mark Chart - User Defined/Preset Logging - Start/Stop Totaliser - Start/Stop/Reset/Reset & Start, Digital Output - ON/OFF Alarm Acknowledge Emails, Screen Change, Print Screen, Counters - Reset/Increment Max/Min (Reset) Chart Control- Pause/Stop/Resume/Clear/Prefil Clear All Messages, Delayed Event Script Timers - Start/Stop/Reset/Reset & Start Play Sound - Start/Stop Display Alert, Reports Batch - Start/Stop/Pause Update Tabular Readings</p>			
Remote Viewer	3	Extends the user interface of the recorder onto the desktop PC. Providing full remote control of the unit launched from a web browser.		
Email	3	Setup email accounts to send the following: When an Alarm is triggered or an Email can be sent as a part of an Event occurring, such as: Alarms - In/Out/Ack , Totaliser – Start, Stop or Reset, Digital Inputs – On, Off or State change, TC Burnout – on a specific Analogue Input channel, Scheduled Events – Once, Interval, Specific days, Month End.		
OPC Server	8	OPC (OLE for Process Control) - Software application for realtime interfacing between servers and clients. OPC is a software standard that defines common interfaces for data exchange between devices such as recorders, controllers, PLC's and Windows™ based applications		
Pwd Net Sync	5	Password Network Synchronisation. Password can be synchronised over the network, a recorder can be designated as a master of a password group and other recorders can be added to that group as slaves, the master will ensure all passwords are synchronised with all recorders in its group. Maximum number of password slaves in one group is 31.		
AMS2750 Process	5	AMS2750 Process activates the Process Mode screen and the AMS2750 process configuration menus for furnaces and sensors in accordance with AMS2750 specification, including Thermocouple tracking.		
Extra Pens	2	4 extra pens to store and display totalised values, results of calculations, etc. Maximum is up to 16 extra pens for the QXe recorder.		

Notes

1. Additional pens ("Extra Pens") can be used to display and store the results of calculations, totalisers, variables imported via communications, or to store values.
2. Event markers are required to automatically reset the totalisers, for example on a periodic basis or on an external condition. (Not necessary if the totalisers are reset manually)
3. Event markers are required to automatically reset the totalisers, for example on a periodic basis or on an external condition. (Not necessary if the totalisers are reset manually).
4. Specification table for Sterilisation: The definition of Fo/Po is the sterilisation/pasteurisation time in minutes required to destroy a stated number of organisms with a known z at temperature T. For example, "F18/250" represents the time in minutes required to destroy a stated number of organisms at a temperature of 250°F (121.11°C) with a z = 18 degrees F. F values are used to compare the sterilizing values of different processes, however, F values cannot be compared unless the z values are the same. When temperature is not specified (for example, F = 8.6) it is understood that the temperature is 250°F (121.11°C); the subscript O (as in the term Fo = 7.4) is used to indicate that the z = 18 degrees F and the temperature is 250°F (121.11°C).

The TrendManager Software Suite

The TrendManager Pro Software Suite complements the capabilities of the “X Series” recorders by providing the benefits of viewing, configuration, network communications, database management, data analysis and report generation using a personal computer. It ties the process together, providing for real-time or FTP communications with the recorders through a Local Area Network (LAN).

TrendViewer

TrendViewer - is the standard software provided with the recorder that displays and prints data imported from the storage media used by the recorder.

TrendManager Pro

TrendManager Pro is an advanced data analysis/archiving software package, providing full configuration of the recorders. TrendManager Pro is a stand-alone package that delivers to the user total recorder configuration, allowing the user to archive, graph, print and export data. TMP also allows files to be exported using comma separated variables (CSV) format that can be imported in most computer software.

TrendServer Pro

TrendServer Pro is a fully network aware software package for real-time viewing and archiving of data with communications to the recorder. It supports all the capabilities of TrendManager Pro plus real-time data acquisition, FTP (File Transfer Protocol) and web browser access. TrendServer Pro provides secure multi-level, multi-user access to the recorder data by various departments with security. Standard features of TrendServer Pro include data archive tools E-mail set up and alarming, graphing, print, import and export data facilities.

TrendServer Pro with OPC Server - provides the same functions as the TrendServer Pro tools, but includes the added function of an integrated OPC Server to allow easy interfacing to third party HMI software packages that support an OPC Client. This provides a real-time interface between servers and clients.

Modbus Profile Configuration Tool - this is a tool that comes as part of the TrendServer Pro software that allows the user to set up Modbus Device Profiles for use by the Communications Server. It allows the user to set up other Modbus devices other than the **X Series** recorders to get real time data into TrendServer Pro.

Communications Server

The Communication Server is supplied with TrendServer Pro. It manages real-time communications, distributed access to the stored data, time synchronisation over RS-485 and Ethernet networks. It is also available with a V2 compliant OPC Server to make it easier to interface third party HMI software packages that support an OPC Client. The Communication Server provides security for the transmission and storage of process data. A Comms option card and expansion card are required for the **eZtrend QXe** recorder.

Database Management Tool

Database Management Tool - this software application works with TrendManager Pro and TrendServer Pro to provide safe administration of data with tools to archive, sort, move, copy and delete the data stored in local and remote databases. The Database Management Tool software is supplied with TrendServer Pro.

IQOQ Protocol Document (TrendServer Pro only.)

Custom built IQOQ reports can be generated based on the configuration of the recorder. The configuration can be validated as a process of confirming that a piece of equipment or process meets the stated requirements to produce a regulated product.

Report Generation Tool - AMS2750

PC software that uses a TUS data file generated by the Multitrend SX recorder to generate a temperature uniformity survey report. It produces a report that documents the uniformity performance of a furnace based on the AMS2750 specification. AMS2750 is the specification that covers pyrometric requirements for thermal processing equipment used for heat treatment.

Minimum System requirements for TrendViewer, TrendManager Pro:	Minimum System requirements for TrendServer Pro:
1GHz Pentium processor or higher	1GHz Pentium processor or higher
CD-ROM drive	CD-ROM drive
Monitor screen resolution 1024 x 768 recommended minimum, high colour	Monitor screen resolution 1024 x 768 recommended minimum, high colour
Microsoft Windows™ 2000, Windows™ XP, Windows™ 2003 server with Standard Edition, Windows™ Vista with Business and Ultimate Edition platforms and networks and Windows 7 (32 bit – Professional and Ultimate Edition)	Microsoft Windows™ 2000, Windows™ XP, Windows™ 2003 server with Standard Edition, Windows™ Vista with Business and Ultimate Edition platforms and networks and Windows 7 (32 bit – Professional and Ultimate Edition)
512 Mbyte of RAM (min 512 Mbyte recommended)	512 Mbyte of RAM (min 512 Mbyte recommended)
16 bit colour graphics, 24 bit recommended	TCP IP installed
50 Mbyte free hard disk space	2 Gbyte Hard-drive free disk space
A mouse	A mouse
Flash card reader or USB port	Flash card reader or USB port

Specification	Design Attributes
Digital indicators and Display	<p><i>Display size and Type:</i> 5.5" diagonal, Digital Colour LCD (TFT) with Touch Screen Industrial grade with brightness adjustment and wide viewing angle</p> <p><i>Resolution:</i> QVGA (320 x 240 pixels).</p> <p><i>Screen Saver:</i> Set in minutes from 1 to 720, can be set to dim the screen or to switch off. Automatic wake-up facility in the case of an alarm.</p> <p><i>Brightness adjustment:</i> Adjustable between 10 and 100%, default set to 80% brightness.</p> <p><i>Backlight life time:</i> 55,000 hours to half brightness when used at 100% (62,500hr if used at 80%). Maximum luminosity 450 cd/m².</p> <p><i>Touch Screen life:</i> 1,000,000 touches</p>
Display Update Rate	Display values updated every second
Status Display	A status bar, at the top of the recorder's screen, displays the real-time icons of the recorder status, such as recording time left and alarm active.
Communications	Ethernet 10/100 base - T with RJ45 connector supporting Modbus/TCP, FTP, Internet, DHCP or fixed IP address. RS485 Modbus RTU (up to 115200 Baud Rate). RS485 port is available as an option on the Comms card.
Mathematics	Basic maths include Add, Subtract, Multiply, Divide, Modulo and power. Full Maths (option) support up to 100 character free form math expression for each pen. For example: SINE, COS, TAN, Log, Parenthesis (eg. A1 + A2), comms variables, free memory, and access to any data item variable (A1, P1, D1 etc.).
Front (std) and Rear (option) USB Ports	USB host ports front (std) and rear (option) for data and setup transfers through these ports. External devices keyboard or mouse, Barcode reader, or external mass storage device. (USB 1.1 compliant)
Standard Screens	Fully programmable display values in engineering units. Time & date stamp on every division. Sets of Standard screens are available to display data on a chart, digital reading, bargraphs or numerous combinations thereof. Screen properties can be modified on the recorder and customised to suit. Digital values displayed include alarms on bars, engineering units, pen name, tag, time and date, 20 character description and totalised values.

Specification	Design Attributes
Power Requirements	<p><i>Voltage (VRMS):</i> 100VAC to 250VAC (auto select). Frequency: 50/60Hz</p> <p><i>Power Consumption:</i> <40W.</p> <p><i>24V Optional instrument power:</i> 20 to 30VDC/20 to 25VAC. Power Consumption: < 40 watts</p>
Battery	<p>Battery backed up for clock, replaceable lithium battery Type 6032, 3.0V – 10 years life (Recorder powered), 4 years life, typical (Recorder un-powered).</p>
Data Storage	<p><i>Local Mass Storage Options (Removable Media):</i> USB memory key - no size restrictions but must be formatted (FAT, FAT16, TFAT, FAT32). USB hard drive - up to 120Gb,</p> <p><i>Internal Data Buffer:</i> Non-volatile. 70MB (16 million acquisition values) and 400MB (up to 90 million points)</p> <p><i>Setup and screens:</i> Stored internally on non-volatile memory</p> <p><i>Manual Saving:</i> Data saving by inserting USB memory stick</p> <p><i>Data Saving Period:</i> Related to log rate, number of pens, totals and alarms. Each pen is capable of its own independent storage rate. (200ms to 60 h).</p> <p><i>Data Format:</i> Honeywell binary encoded format</p> <p><i>Recycling Mode:</i> Internal memory has FIFO (First In First Out) capability where the newest data over-writes the oldest data.</p>
Password Protection	<p>Multiple Administrator control of password setup and management with four levels of password protection for – Engineer, Supervisor, Technician, and Operator. Up to 50 different users are available. Password protection restricts user entry to the recorder set up and specific screens.</p> <p>Engineer – Highest access to all levels, Supervisor, Technician and Operator.</p> <p>Supervisor – 2nd highest level including Technician and Operator access</p> <p>Technician – 3rd level including Operator access</p> <p>Operator – 4th and lowest level of access.</p>
Languages	<p>English UK & US, French, German, Italian, Spanish, Brazilian, Polish, Hungarian, Slovakian, Czech, Turkish, Romanian, Russian, Portuguese, Greek, Chinese, Japanese, Korean and</p>
Temperature Units	<p>°C, °F, °K</p>
Recorder Identification	<p>Status bar: Alternately displays Recorder ID and Recorder Screen Name. Displays Time and Date.</p>
Clock	<p>Accuracy: ±29ppm (±1 minute/month) @ 25°C.</p> <p>Summer/Winter manual or automatic time adjustment or via communications. SNTP Client and/or Server included for synchronising over Ethernet.</p>
Alarm Set Points	<p>6 per pen integral “soft” alarm set points easily set by user to announce selected out of limit conditions; user can select if an alarm triggers a change in the chart background colour. Alarm triggers can be set for Hi, Lo, Deviation. Latched alarms require acknowledgement from the operator. Alarm Damping - 1 sec to 24 Hours; Hysteresis - +/- 100% of pen scale. An alarm can change the log rate on the affected pen.</p>
Data Replay Mode	<p>Data replay facility on chart displays at normal, fast or slow speeds with zoom and cursor. Jump facility from the alarm history list directly to the occurrence on the chart.</p>
Display Chart Speeds	<p>Chart rates: 1 mm/hour, 5 mm/hour, 10 mm/hour, 20 mm/hour, 30 mm/hour, 60 mm/hour, 120 mm/ hour, 600 mm/hour, 1200 mm/hour, 6000 mm/hour. Combinations of rates can be mixed and chart speeds can be set independently for each chart. Display speeds are independent of logging rate</p>
Messages Screen	<p>The message screen displays system information and records any setup activity that has been changed. It also provides warning and error message updates, lists alarm activity and will display user defined marks on a chart.</p>

Specification	Design Attributes
CE Conformity (CE Mark)	This product conforms with the protection requirements of the following European Council Directives: 73/23/EEC, the Low Voltage Directive, and 89/336/EEC, the EMC Directive. Conformity of this product with any other "CE Mark" Directive(s) shall not be assumed.
Immunity Product Classification	Complies with EN61326 Class I: Cord Connected, Panel Mounted Industrial Control Equipment with protective earthing (grounding). (EN 61010-1)
Enclosure Rating	Front panel designed to NEMA3 / IP54 (Optional NEMA 4X / IP66)
Installation Requirements	Category II: Overvoltage (EN 61010-1) Pollution Degree 2
EMC Standards	Emissions - EN61326 Class A Immunity - EN61326 Industrial Levels
Safety	Complies with EN61010-1: 2001. Panel Mounted Equipment, Terminals must be enclosed within the panel.

Specification	Analogue Inputs
Number of Inputs	3, 6, 9 or 12 input channels
Input Types	mV, V, mA with external shunt (provided as standard), Thermocouple, RTD and ohms
Minimum Input Span	Range is fully configurable with span limitation of the operating range selected with 4% under range to 4% over-range capability (50V Range 2%)
Burnout (T/C)	Active (High or Low), Passive and Health watch/maintenance (option).
Cold Junction Compensation	Internal compensation with the ability to manually adjust values, External Input for compensation, External CJC value specified
Input Resolution	0.0015% (16 Bit ADC)
Input Impedance	Current loop resistance: 10 ohms, use $\pm 0.1\%$ external resistor. Volts $> 1M\Omega$, all other
Source Impedance	T/C and RTD: 100 ohms per lead maximum. (A single point cal on Slot A will improve accuracy for a lead resistance above 10 ohms).
Square Root Extraction	Available as standard on Volts and mA input types
Sensor Compensation	Single point and Dual point for every input type
Input Sampling Rate	Recorder has 2 available slots with up to 6 analog inputs each; first slot fixed. Analogue Input card (std): 200mS (5Hz), 500mS (2Hz) Analogue Input expansion card (option): 100mS (10Hz), 200mS (5Hz), 500mS (2Hz)
Scales, Linear & Logarithmic	Normal and Scientific notation. Decimal Point automatic or programmable Engineering units, user definable (10 characters). Logarithmic Decade limits: -38 min, to +38 max, (recommend up to 20 decades on one screen to ensure clarity)
Input Isolation	300VAC channel-to-channel, channel-to-ground. (Resistance thermometers are not isolated for initial card, expansion card option RTs are isolated)
Noise Rejection (at 50/60Hz) +/-2%	Analogue Input card (std) Common mode: 2Hz = -120dB, 5Hz = -120dB Normal Mode: 2Hz = -80dB, 5Hz = -25dB Analogue Input expansion card (option) Common mode: 2Hz = -120dB, 5Hz = -120dB, 10Hz = -120dB Normal Mode: 2Hz = -85dB, 5Hz = -80dB, 10Hz = -48dB

Specification Logging	
Logging Method	Sample, Average, Min/Max - can be set independently per pen
Logging Types	Continuous, Fuzzy
Logging Rate	From 100msec. to 60 hours per pen
Fuzzy Logging	A secure data storage technique which delivers data compression ratio of 100:1 or more; self teaching, storing the data at a variable rate to match the process

Specification Physical Parameters	
Enclosure/Bezel	Zinc plated steel case with high impact resistant polycarbonate bezel; scratch resistant lens (Polyethylene Terephthalate). NEMA 3 / IP54 protection rating standard. Optional NEMA 4X / IP66 (Front face only)
Mounting Panel	Unlimited mounting angle. For the best view of the display the viewing angle should not exceed 45° from the left or right, 10° looking down and 30° looking up at the recorder display. Mounting adjustable for panel thickness of 2mm to 20mm. Adapter kits available for covering existing panel cutouts.
Dimensions	W: 144mm (5.67"), H: 144mm (5.67"), D: 200mm (7.87"). Additional 80mm (3.15") clearance recommended for a straight type power cable and signal connectors. Cutout 138 x 138mm (5.43 x 5.43")
Weight	2.4 Kg (5.3lb) max.
Colour	Bezel: Black
Wiring Connections	IEC Power Plug. Removable terminal strip for input and alarm connections

Input Range Performance and Accuracy

For Analogue Input standard and expansion cards

Input Actuation (Linear)	Range	Accuracy	Temp. Stability +/-	Input Impedance
Millivolts DC	-5 to 5, -10 to 10,	+/- 0.2% F.S.	0.01%/ °C	>10M ohms
	-25 to 25, -50 to 50, -100 to 100,	+/- 0.1% F.S.	0.01%/ °C	>10M ohms
	-250 to 250, -500 to 500, -1000 to 1000	+/- 0.1% F.S.	0.01%/ °C	>10M ohms
Volts DC	-0.3 to 0.3, -0.6 to 0.6, -1.5 to 1.5,	+/- 0.1% F.S.	0.01%/ °C	>1M ohms
	-3 to 3, -6 to 6, -12 to 12,	+/- 0.1% F.S.	0.01%/ °C	>1M ohms
	-25 to 25, -50 to 50	+/- 0.1% F.S.	0.01%/ °C	>1M ohms
Milliamps **	4 to 20, 0 to 20	+/- 0.2% F.S.	0.01%/ °C	
Ohms, 200	0 to 200	+/- 0.1% F.S.	0.01%/ °C	
Ohms, 500	0 to 500	+/- 0.1% F.S.	0.01%/ °C	
Ohms, 1000	0 to 1000	+/- 0.1% F.S.	0.01%/ °C	
Ohms, 4000	0 to 4000	+/- 0.1% F.S.	0.01%/ °C	

Input Actuation (Thermocouples)	Range		Reference Accuracy		Temp. Stability +/-
	°F	°C	+/- °F	+/- °C	
B*	500 to 1000	260 to 538	8.1	4.5	0.01%/ °C
	1000 to 3300	538 to 1816	4.0	2.2	
E*	-454 to -328	-270 to -200	21.6	12	0.01%/ °C
	-328 to -94	-200 to -70	3.1	1.7	
	-94 to 1832	-70 to 1000	1.3	0.7	
J*	-346 to 32	-210 to 0	3.1	1.7	0.01%/ °C
	32 to 2192	0 to 1200	1.2	0.7	
K*	-454 to -94	-270 to -70	36	20	0.01%/ °C
	-94 to 2502	-70 to 1372	1.8	1	
R*	-58 to 500	-50 to 260	9.0	5.0	0.01%/ °C
	500 to 1202	260 to 650	3.6	2	
	1202 to 3214	650 to 1768	2.7	1.5	
S*	-58 to 500	-50 to 260	6.3	3.5	0.01%/ °C
	500 to 1832	260 to 1000	3.2	1.8	
	1832 to 3214	1000 to 1768	2.7	1.5	
T*	-454 to -346	-270 to -210	9.7	5.4	0.01%/ °C
	-346 to 752	-210 to 400	1.8	1	
L*	-328 to 32	-200 to 0	2.2	1.2	0.01%/ °C
	32 to 1652	0 to 900	1.3	0.7	
G* (W_W26)	32 to 212	0 to 100	45	25	0.01%/ °C
	212 to 600	100 to 316	11.2	6.2	
	600 to 1526	316 to 830	5.0	2.8	
	1526 to 2759	830 to 1515	3.1	1.7	
	2759 to 4199	1515 to 2315	5.0	2.8	

Input Actuation (Thermocouples)	Range		Reference Accuracy		Temp. Stability +/-
	°F	°C	+/- °F	+/- °C	
C* (W5, W26)	32 to 356	0 to 180	4.5	2.5	0.01%/ °C
	356 to 2228	180 to 1220	3.6	2	
	2228 to 4199	1220 to 2315	6.7	3.7	
M* (NiMo-NiCo) (NNM90)	-58 to 698	-50 to 370	2.0	1.1	0.01%/ °C
	698 to 2570	370 to 1410	1.4	0.8	
N* (Nicosil Nisil)	-328 to 212	-200 to 100	5.8	3.2	0.01%/ °C
	212 to 2372	100 to 1300	2.0	1.1	
Chromel/Copel*	-58 to 1112	-50 to 600	1.1	0.6	0.01%/ °C
P* (Platinel)	32 to 2534	0 to 1390	2.5	1.4	0.01%/ °C
D*	32 to 356	0 to 180	6.3	3.5	0.01%/ °C
	356 to 3344	180 to 1840	4	2.2	
	3344 to 4515	1840 to 2490	11.7	6.5	

Input Actuation (Linear)	Range		Accuracy		Temp . Stability +/-	Input Impedance
PT100 $\alpha = 0.00385$	-328 to 1562	-200 to 850	1.1	0.6	0.01%/ °C	
PT200 $\alpha = 0.00385$	-328 to 1562	-200 to 850	1.1	0.6	0.01%/ °C	
PT500 $\alpha = 0.00385$	-328 to 1562	-200 to 850	1.1	0.6	0.01%/ °C	
PT1000 $\alpha = 0.00385$	-328 to 1562	-200 to 850	1.1	0.6	0.01%/ °C	
100 ohm Nickel	-76 to 356	-60 to 180	0.9	0.5	0.01%/ °C	
120 ohm Nickel	-112 to 500	-80 to 260	0.5	0.3	0.01%/ °C	

Reference Temperature: 22°C

Reference Sample Rate: 2Hz (500msec)

Reference Humidity: 65% RH +/-15%

Long term stability: 0.2%/year

* Does not includes reference junction calibration of ± 1.0 °C using the standard "ice bath" method of calibration. Factory accuracy can be improved by performing a field calibration. Also does not include any error on the sensor.

** Tolerance for these input types includes that of the external shunt resistors (0.1% tolerance)

Specification	Options
Alarm Outputs (optional)	Programmable alarm set points (6 per pen) can be configured to activate up to 8 outputs. Update rate: 200 ms for all alarms. Number/Type: <ul style="list-style-type: none"> • 4 or 8 relay contacts SPDT, 3A 240VAC, 3A 24VAC/DC, 0.2A 240VDC (non-inductive, internally suppressed) • 8 I/O - SPNO 1A 24VDC (non-inductive, internally suppressed) Activation: Fully programmable internal alarm levels. Assignable to any relay output.
Digital Input/Output (optional)	8 I/O: all channels may be selected freely as either digital inputs or outputs. Inputs: voltage free, isolated. The Digital I/O card also has 4 channels that can be set as pulse inputs (channels 1 to 4). The operating frequency for pulse inputs on the Digital I/O card is 1kHz max. 4 relay outputs: all four channels are relay outputs only. 8 relays/ 2 DI card: two outputs can be configured for use as digital inputs: A digital input is provided by a volt free contact between the normally open (NO) and the common (C) terminals of an output relay. If the 2 Digital inputs are used only 6 relay outputs are available. Closed <500 ohms, Open >300 kohms.
Agency Approval (optional)	CSA (Optional) CSA22.2-No.1010.1-2004 Certificate Number L211230. UL (Optional) ANSI/UL61010-1-2004 File # 201698.
Transmitter Power (optional)	130mA @ 24VDC ± 3VDC.
Miscellaneous	Optional customer ID Tagging (3 lines of up to 22 characters each line)
Firmware credit options	Maths (Basics, Full, Scripting), Events, Totals, Reports, Health Watch/Maintenance, Printing, Batch, Counters, Modbus Master, Remote View, Email, OPC, Password Net Sync, AMS2750 Process, Extra Pens. Firmware Credit System on page 7

Specification	Environmental and Operating Conditions			
Parameter	Reference	Rated	Extreme	Transport & Storage
Ambient Temperature	67 °F to 77 °F 19 °C to 25 °C	32 °F to 122 °F 0 °C to 50 °C	32 °F to 122 °F 0 °C to 50 °C	14 °F to 140 °F -10 °C to 60 °C
Relative Humidity (%RH)	50 to 65*	10 to 90*	5 to 90*	5 to 95*
Vibration				
Frequency (Hz)	0	0 to 70	0 to 100	0 to 100
Acceleration (g)	0	0.1	0.2	0.5
Mechanical Shock				
Acceleration (g)	0	1	5	20
Duration (ms)	0	30	30	30
Mounting Position from Vertical				
Tilted Forward	5°	40°	40°	Any
Tilted Backward	5°	65°	65°	Any
Tilted to Side (+/-)	5°	65°	65°	Any
Power Requirements				
Mains Voltage (Vrms)	220 to 240	100 to 250	90 to 264	N/A
Low Voltage AC (Vrms)	24 +/- 2	20 to 25	20 to 25	N/A
DC Voltages	24 +/- 2	20 to 30	20 to 30	N/A
Frequency (Hz)	49.8 to 50.2	47 to 63	47 to 63	N/A
Power Consumption	AC: <40W (max), DC: <40W (max). Typical 20W			
Warm Up	30 minutes minimum			

The maximum rating only applies up to 104°F (40°C). For higher temperatures, the RH spec is de-rated to maintain constant moisture content.

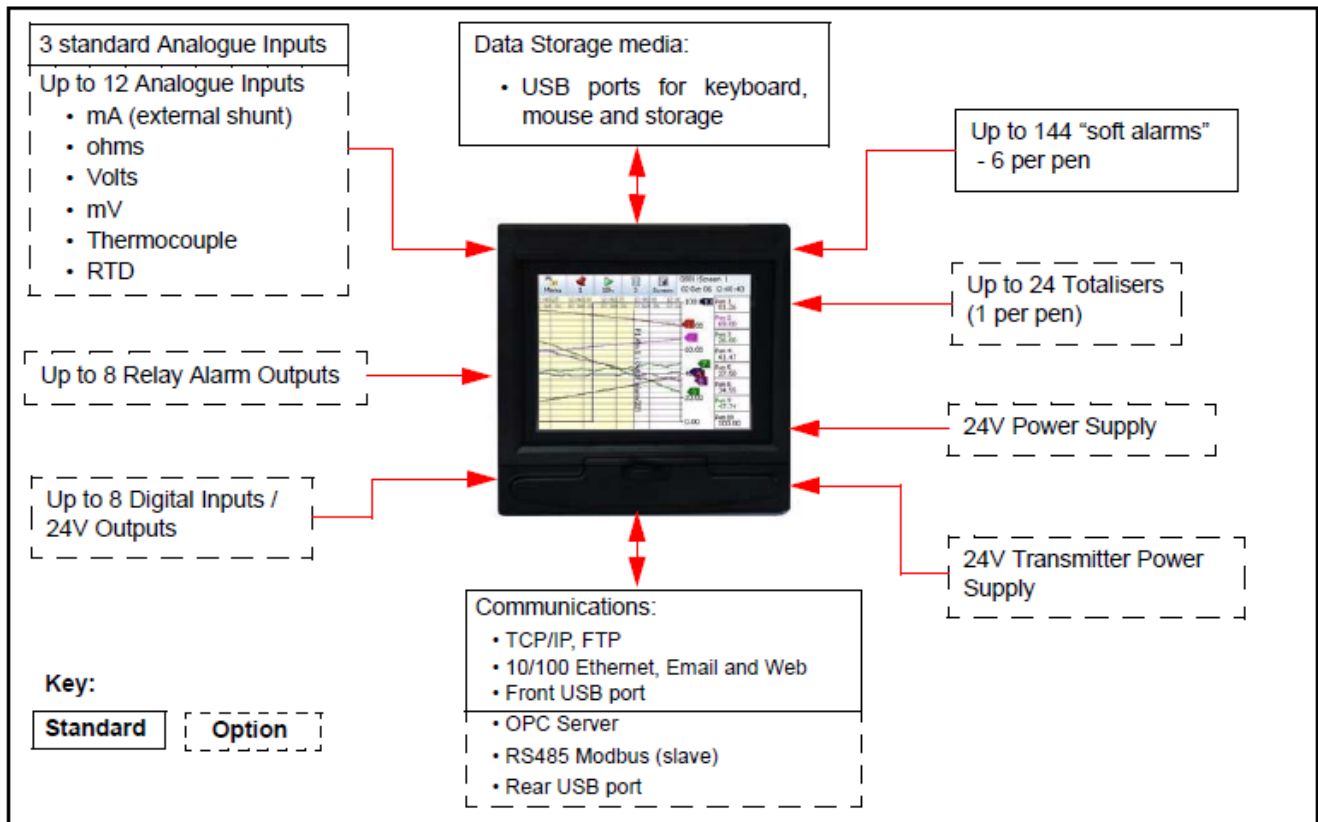

Connections

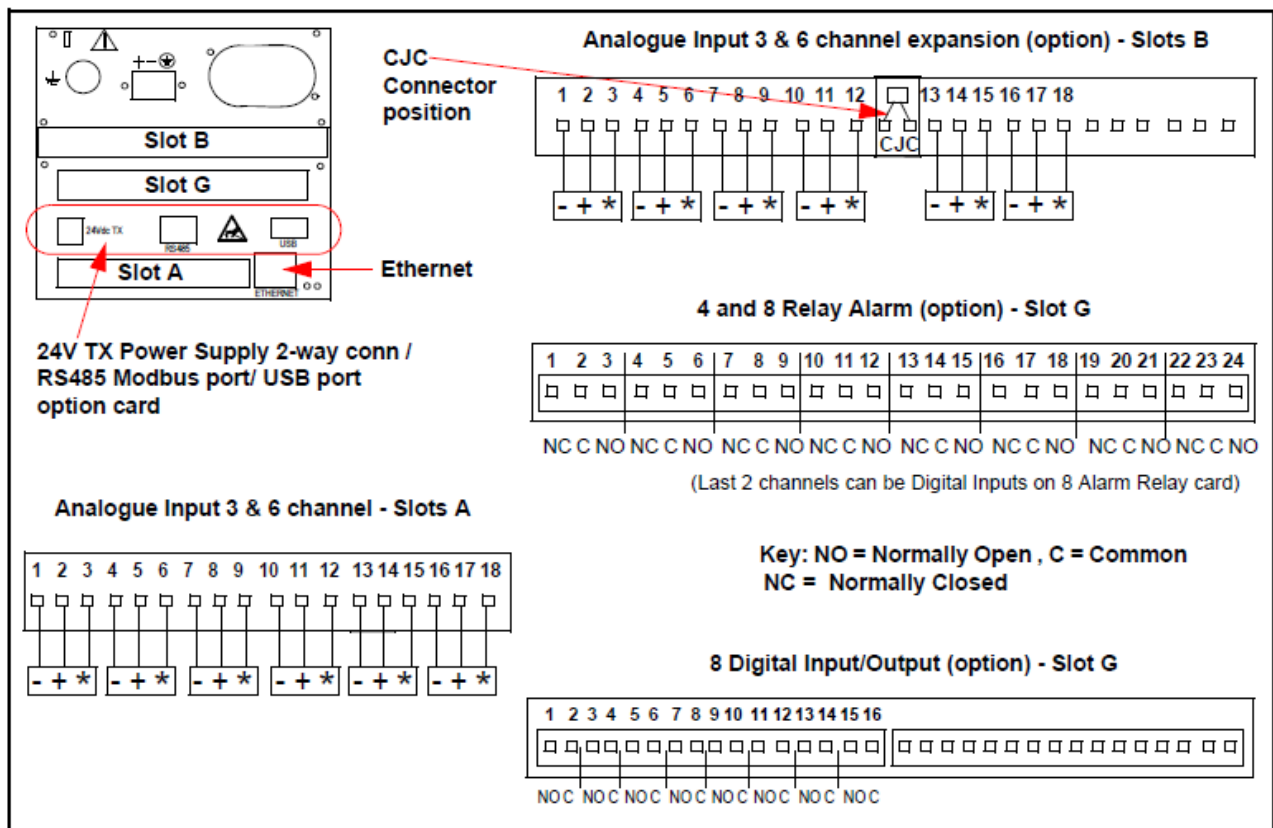

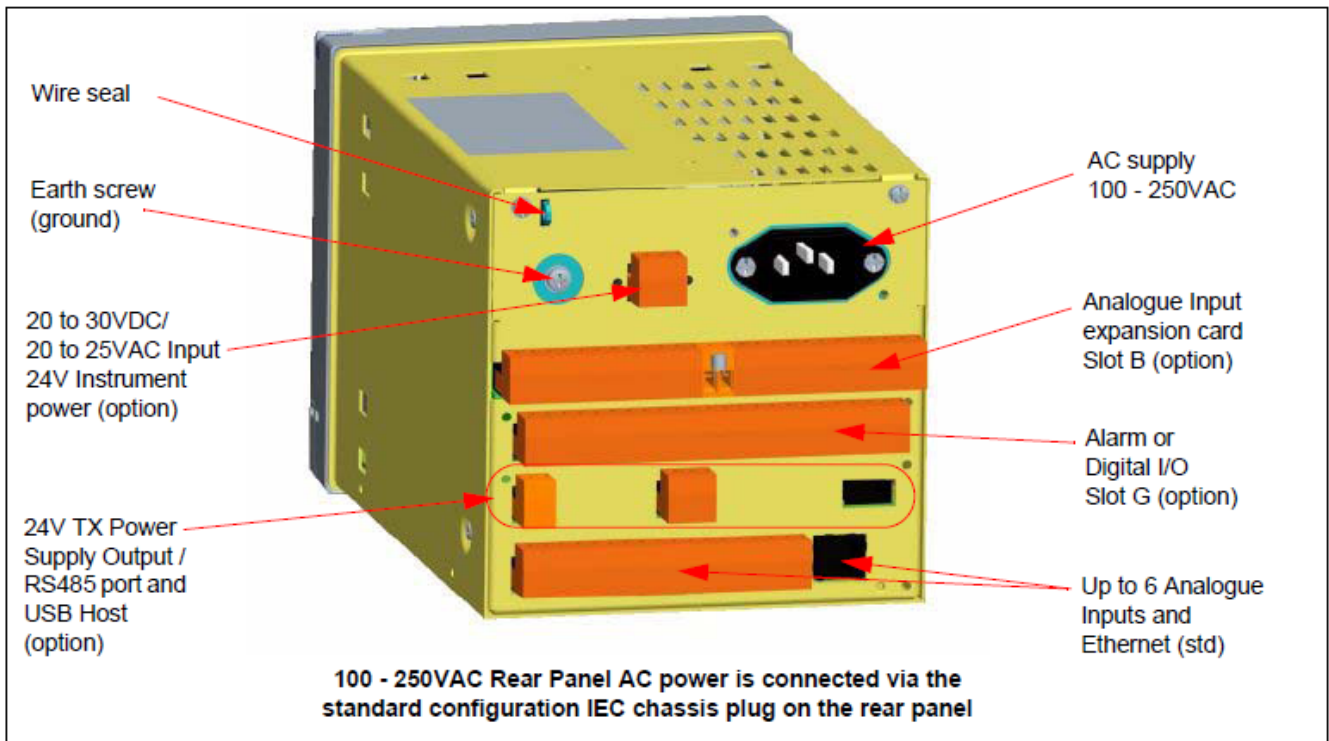

Installation

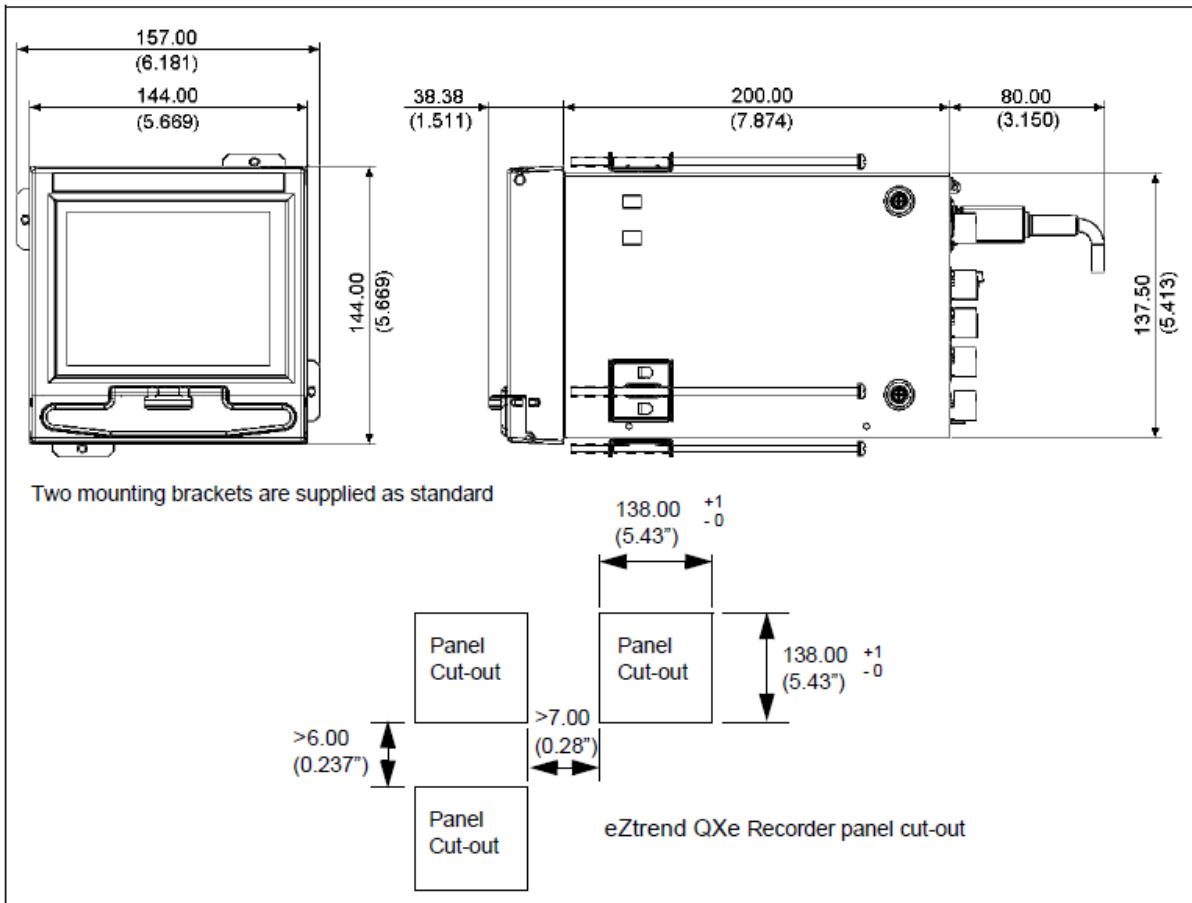

Model Selection Guides are subject to change and are inserted into the specifications as guidance only. Prior to specifying or ordering a model check for the latest revision Model Selection Guides which are published at: <https://www.honeywellprocess.com/en-US/explore/products/instrumentation/recorders-and-data-acquisition/paperless-recorders/Pages/eztrend-qxe.aspx>
Model Selection Guide (34-XY-16-14)

eZtrend QXe Recorder

Model Selection Guide

43-TV-16U-14
 Issue 12
 Page 1 of 3

The eZtrend QXe represents the latest in data acquisition and recording. Standard features include Active Matrix TFT display, Ethernet communications, USB port, touch screen interface for easy configuration and navigation, NEMA 3 front face plus a wide selection of optional features to handle most data acquisition applications. A USB Key is included with the recorder.



Instructions

Make the desired selections from Option Tables using the column below the arrow.
 A dot (●) denotes unrestricted availability. Restrictions follow Table VII.

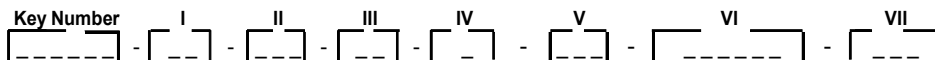

KEY NUMBER	Selection	Availability
eZtrend QXe Advanced Graphics Recorder with TFT Display and Touch Screen Interface	TVEZQX	↓

TABLE I - ANALOG INPUTS/EXPANSION CARD

Analog Inputs	Three Analog Inputs (Analog 1 - 3)	(Note 1)	3 _	●
	Six Analog Inputs (Analog 1 - 6)	(Note 1)	6 _	●
Expansion Card	None		_ 0	●
	Expansion Board for Table II Option Cards	(Note 2)	_ 1	●

TABLE II - Hardware Options

Analog Inputs	None		0 _ _	●
	Six Additional Analog Inputs (Analog 9 - 14)	(Note 3)	6 _ _	c
Discrete Inputs/ Outputs	None		_ 0 _	●
	Four Relay Outputs		_ 1 _	c
	8 Relay/2 Digital Inputs-6 Fixed Outputs/2 Configurable DI/DO	(Note 4)	_ 2 _	c
	8 Configurable Digital Inputs/Discrete 24V Outputs	(Note 5)	_ 3 _	c
Comms/Xmtr	None		_ _ 0	●
Power Options	24Vdc Transmitter Power, Rear USB, RS485 Comm Port		_ _ U	d
	Rear USB Port, RS485 Comm Port		_ _ V	e

TABLE III - POWER

Power	90 - 240 VAC with IEC Power Plug		1 _	●
	90 - 240 VAC with US Power Cord		2 _	●
	24VDC Instrument Power	(Note 6)	5 _	●
Input Frequency	50 Hz	(Note 7)	_ 1	●
Filter Value	60 Hz	(Note 7)	_ 2	●

TABLE IV - INTERNAL MEMORY FOR DISPLAY/DATA STORAGE

Memory Card	None - (Standard 70MB)		0	●
	400 MBytes		2	●

43-TV-16U-14
Issue 12
Page 2 of 3

TVEZQX

TABLE V - FIRMWARE CREDITS/OPTIONS

		Selection	Availability
Security/Firmware Credits	None	0 __	•
	Extended System Security	S _	•
	None	_ 0 _	•
	Ten Credits	_ 1 _	•
	Twenty Credits	_ 2 _	•
	Thirty Credits	_ 3 _	•
	Fifty Credits	_ 5 _	•
	Sixty Credits	_ 6 _	•
	None	_ _ 0	•
	Two Credits	_ _ 2	•
	Five Credits	_ _ 5	•
	Eight Credits	_ _ 8	•

CREDITS - Decide what functions are needed and select that many total "Credits" when ordering firmware options. For Example: If Math, Events and Totals are needed for the application, sum the values for each function listed below to determine the number of credits to purchase. Additional credits are available if needed using the Upgrade Procedure Credits can be selected/deselected and used interchangeably as long as the total credits purchased is not exceeded. Maximum number of credits required to enable all functions is 69 credits.

VALUE	FUNCTION
2	Health/Maintenance
2	Print Function
2	4 Extra Pens
3	Reports
3	Remote Viewing

(Note 8)
(Note 9)

VALUE	FUNCTION
3	Counters
3	e-Mail
4	Totals
4	Full Maths
5	Batch

VALUE	FUNCTION
5	AMS2750 Process Mode
5	Password Net Sync
6	Events
8	OPC Interface
10	Modbus Master

(Note 17)
(Note 15)
(Note 16)

TABLE VI - OPTIONS

Case/Mounting (Note 12)	Standard Panel Mounting	0 _ _ _ _	•
	Standard Panel Mounting with Rear cover	R _ _ _ _	•
Documentation Manuals (Note 14)	Product Information on CD with TrendViewer	_ 0 _ _ _	•
	English Manual & Language Prompts with TrendViewer	_ U _ _ _	•
	French Language Prompts Manual with TrendViewer	_ F _ _ _	•
	German Language Prompts Manual with TrendViewer	_ G _ _ _	•
	English Manual & English/Chinese Prompts & TrendViewer	_ C _ _ _	•
	English Manual & English/Korean Prompts & TrendViewer	_ K _ _ _	•
Tagging	English Manual & English/Japanese Prompts & TrendViewer	_ J _ _ _	•
	None	_ _ 0 _ _	•
	Linen Tag (Note 10)	_ _ L _ _	•
	Stainless Steel Tag (Note 10)	_ _ S _ _	•
Standards	CE Mark/IP54/NEMA 3	_ _ _ 0 _	•
	CE Mark/IP66/NEMA 4X	_ _ _ 1 _	•
	CE Mark, UL Listed & CSA Approval/IP66/NEMA 4X	_ _ _ 3 _	•
Certificates	None	_ _ _ 0 _	•
	Certificate of Conformance (F3391)	_ _ _ B _	•
	Custom Calibration Test Report (F3399) (Note 11)	_ _ _ C _	•
	Certificate of Conformance & Calib. Test Report (Note 11)	_ _ _ E _	•
Software (Note 13)	None	_ _ _ _ 0	•
	Trend Manager Pro (Single User License)	_ _ _ _ P	•
	Trend Server Pro (Single User License)	_ _ _ _ S	•
	Trend Server Pro with OPC capability (Single User License)	_ _ _ _ T	•

TABLE VII

Factory Use Only	Standard Honeywell Version	000	•
------------------	----------------------------	-----	---

RESTRICTIONS

Restriction Letter	Available Only With		Not Available With	
	Table	Selection	Table	Selection
c	I	_ 1		
d	I	_ 1	III	5 _
e	I	_ 1		
	III	5 _		

43-TV-16U-14**Issue 12****Page 3 of 3****Notes:**

1. Standard inputs include T/C, mV, V, mA, Ohms and RTD actuations.
2. This option is required when ordering any hardware option in Table II, in case of future hardware upgrades, the Expansion Board for these options can be added using P/N 50012927-501.
3. Analog input card supports T/C, mV, V, mA, Ohms & RTD actuations. These inputs provide enhanced input isolation.
4. Relay Outputs are high level outputs (240VAC/3 Amp non inductive loads).
5. Discrete Outputs are low level outputs (24VDC/1 Amp non inductive loads). Any channel on the 8 Discrete I/O Card can be used as a Digital Input if not used as an Alarm Output. Up to 4 channels can be used as a Pulse Input up to 1KHz.
6. For 24V Instrument Power, the Input Filter Frequency Noise Rejection can be ordered set for either 50 or 60 Hz
7. Factory set to this frequency but configurable in the set up menu to the other frequency setting
8. The Print function can print screens from the Recorder to a PCL type printer.
9. Maximum number of Extra Pens available is 12. Extra Pens can be used to write analog values to the recorder using the Modbus protocol without needing the full complement of analog inputs. Using all the virtual pens with many complicated maths and other functions can affect the overall performance of the recorder.
10. Customer must supply tagging information, Up to 3 lines of 22 characters each are allowed
11. Calibration Test Reports/Certificates require specific Range and Input Actuation data from the customer. Form F3399 Supplemental Data must be completed. This can be downloaded from the Honeywell SaleNet site or the Global Technical Services site: <http://content.honeywell.com/ipc/faq/>
12. Portable Case, Rear Cover and Carrying Handle Options can be ordered separately (see Accessories price page)
13. Software Packages can be ordered separately (see Accessories price page)
14. The recorder supports local language prompts for the following languages: English, French, German, Italian, Spanish, Brazilian, Polish, Hungarian, Slovakian, Czech, Turkish, Romanian, Russian, Portuguese, Greek and Bulgarian. For Chinese option, it does not contain Korean or Japanese prompts, for Japanese Option it does not contain Chinese or Korean prompts and for Korean option it does not contain Chinese or Japanese Prompts.
15. The events currently include: Into, Out of and Alarm Ack, Start, Stop, Reset, Reset and Start Totals, Digital Input ON/OFF/State Change, Scheduled-Once/Intervall/Specific Days/Month End, User Counters, Reset Max/Mins, Emails, Screen Change, Print Screen, Counters-Reset/Increment, Chart Control-Pause/Stop/Resume/Clear/Prefill, Clear All Messages, T/C Burnout, Mark Chart, Start/Stop Logging, Digital Output ON/OFF, System-Power ON, Setup Change, Internal Memory Low, Export Memory Low, FTP Memory Low, User Action-Mark Chart, Batch-Start/Stop/Pause, Delayed Event, Script Timers - Start/Stop/Reset/Reset & Start, Play Sound-Start/Stop, Display Alert, Reports, TUS - Start/Stop, AMS2750 Timer - TC Timers/Process Timers, Update Tabular Readings.
16. To write Modbus Slave values to the pens using Modbus Master requires FF Math or Math Scripts to assign these values to a pen.
17. AMS2750 Process Mode credits allow the user to monitor T/C Usages, SAT Cal Due Date, TUS Due Date, Instrument Cal Due Date and Control T/C Due Date.

Sales and Service

For application assistance, current specifications, pricing, or name of the nearest Authorized Distributor, contact one of the offices below.

ASIA PACIFIC

(TAC) hfs-tac-support@honeywell.com

Australia

Honeywell Limited
Phone: +(61) 7-3846 1255
FAX: +(61) 7-3840 6481
Toll Free 1300-36-39-36
Toll Free Fax:
1300-36-04-70

China – PRC - Shanghai

Honeywell China Inc.
Phone: (86-21) 5257-4568
Fax: (86-21) 6237-2826

Singapore

Honeywell Pte Ltd.
Phone: +(65) 6580 3278
Fax: +(65) 6445-3033

South Korea

Honeywell Korea Co Ltd
Phone: +(822) 799 6114
Fax: +(822) 792 9015

EMEA

Phone: + 80012026455 or +44
(0)1202645583
FAX: +44 (0) 1344 655554
Email: (Sales) sc-cp-apps-salespa62@honeywell.com
or
(TAC) hfs-tac-support@honeywell.com

NORTH AMERICA

Honeywell Process Solutions,
Phone: 1-800-423-9883
Or 1-800-343-0228
Email: (Sales) ask-ssc@honeywell.com or
(TAC) hfs-tac-support@honeywell.com

SOUTH AMERICA

Honeywell do Brazil & Cia
Phone: +(55-11) 7266-1900
FAX: +(55-11) 7266-1905
Email: (Sales) ask-ssc@honeywell.com or
(TAC) hfs-tac-support@honeywell.com

eZtrend QXe is a registered trademark of Honeywell International Inc.

Specifications are subject to change without notice.

For More Information

Learn more about how Honeywell's eZtrend® QXe can provide flexible electronic data acquisition, visit our website www.honeywellprocess.com/eztrend-qxe or contact your Honeywell account manager.

Honeywell Process Solutions

1860 West Rose Garden Lane
Phoenix, Arizona 85027
Tel: 1-800-423-9883 or 1-800-343-0228
www.honeywellprocess.com



43-TV-03-12
February 2013
© 2013 Honeywell International Inc.