

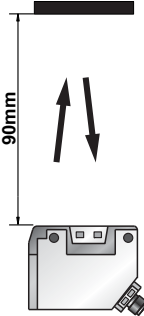











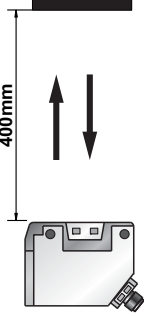

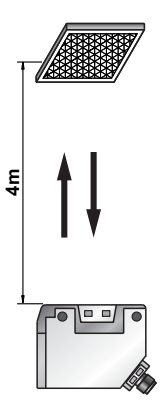

Diffuse Mode

Sensing Mode	Connection	Supply Voltage	Output Mode	Part Number
 <p>90mm</p> <p>Diffuse Mode (Fixed-focus)</p> <p>Sensing Distance: 90mm</p>	2m Cable 	10-30V DC	NPN	
			PNP	
			—	—
	Quick Disconnect (Pico-style) 	10-30V DC	NPN	
			PNP	
			—	—
	6" Pig Tail (Pico-style) 	10-30V DC	NPN	
			PNP	
			—	—
 <p>400mm</p> <p>Diffuse Mode</p> <p>Sensing Distance: 400mm</p>	2m Cable 	10-30V DC	NPN	RP32-D0400N-CY6C4U2
			PNP	RP32-D0400P-CY6C4U2
			—	—
	Quick Disconnect (Pico-style) 	10-30V DC	NPN	RP32-D0400N-CY6Q4UP
			PNP	RP32-D0400P-CY6Q4UP
			—	—
	6" Pig Tail (Pico-style) 	10-30V DC	NPN	RP32-D0400N-CY6P4UP
			PNP	RP32-D0400P-CY6P4UP
			—	—

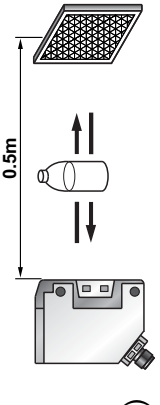



Note:
 Coming Soon : Part numbers with underline
 In Preparation: Part numbers with a line through the middle
 — Ac-01 —

Retroreflective Mode

Sensing Mode	Connection	Supply Voltage	Output Mode	Part Number	
 <p>Retro-reflective Mode With Polarizing filter Sensing Distance:4m (Note)</p>	2m Cable 	10-30V DC	NPN	RP32-L4000N-CY6C4U2-PF	
				PNP	RP32-L4000P-CY6C4U2-PF
				—	—
		Quick Disconnect (Pico-style) 	10-30V DC	NPN	RP32-L4000N-CY6Q4UP-PF
				PNP	RP32-L4000P-CY6Q4UP-PF
				—	—
		6" Pig Tail (Pico-style) 	10-30V DC	NPN	RP32-L4000N-CY6P4UP-PF
				PNP	RP32-L4000P-CY6P4UP-PF
				—	—
 <p>Retro-reflective Mode Clear Material Sensor Sensing Distance:0.5m (Note)</p>	2m Cable 	10-30V DC	NPN	RP32-L0500N-CY6C4U2-PD	
				PNP	RP32-L0500P-CY6C4U2-PD
				—	—
		Quick Disconnect (Pico-style) 	10-30V DC	NPN	RP32-L0500N-CY6Q4UP-PD
				PNP	RP32-L0500P-CY6Q4UP-PD
				—	—
		6" Pig Tail (Pico-style) 	10-30V DC	NPN	RP32-L0500N-CY6P4UP-PD
				PNP	RP32-L0500P-CY6P4UP-PD
				—	—

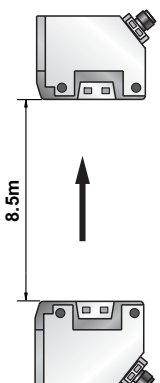
Note: Used with RE-6152 (supplied with sensor) reflector.
 Coming Soon : Part numbers with underline
 In Preparation : Part numbers with a line through the middle
 — Ac-02 —

Thru-beam Mode

Sensing Mode	Connection	Supply Voltage	Output Mode	Part Number
 <p>8.5m</p> <p>Thru-beam Mode</p> <p>Sensing Distance: 8.5m</p>	2m Cable 	10-30V DC	Emitter	RP32-T8500D-EY6C3L2
			NPN	RP32-T8500N-CY6C4U2
			PNP	RP32-T8500P-CY6C4U2
	Quick Disconnect (Pico-style) 	10-30V DC	Emitter	RP32-T8500D-EY6Q4LP
			NPN	RP32-T8500N-CY6Q4UP
			PNP	RP32-T8500P-CY6Q4UP
	6" Pig Tail (Pico-style) 	10-30V DC	Emitter	RP32-T8500D-EY6P4LP
			NPN	RP32-T8500N-CY6P4UP
			PNP	RP32-T8500P-CY6P4UP

Ac: RP32 SERIES

Note:
 Coming Soon : Part numbers with underline
 In Preparation: Part numbers with a line through the middle

Specifications

Sensing Mode	Diffuse Mode	Fixed-focus Diffuse Mode	Retro-reflective (with polarizing filter)	Clear Material Type Sensor	Thru-beam Mode
Sensing Range, Adjustable	400 mm	90 mm	4m (Note)	0.5m (Note)	8.5m
Angle of Divergence	approx. 5°	—	approx. 4.5°	—	approx. 3.5°
Light spot size	approx. 40mm @ 400mm	approx. 3.5mm @ 40mm	approx. 200mm @ 2.5m	approx. 30mm @ 0.5m	approx. 440mm @ 7m
Focal Distance	—	40 mm	—	—	—
Response Time/Frequency	<0.7 ms / 700 Hz				<1 ms / 500 Hz
Threshold	from 20% light attenuation, variable. (Only for clear material sensor)				
Light Source	LED Red				
Supply Voltage	10...30V DC (limit values)				
Current Consumption (no load)	≤30 mA				
Ripple (within Vs tolerance)	10%				
Output Type	PNP, NPN				
Output Voltage High	PNP: Vs - (≤1.5V); NPN: approx. Vs.				
Output Voltage Low	PNP: approx. 0V; NPN: ≤1.5V.				
Output Current Max.	100 mA				
Operation Mode	Light or dark switching selectable via control wire				
Connections	Cable type: PVC 2m, 4x24 AWG (Emitter of thru-beam mode: 3x24 AWG) Connector type: M8(pico-style) connector, Pigtail type: 6" cable+M8(pico-style) connector(other type on request)				
Housing Material	Stainless steel/ABS				
Enclosure Rating	IP 67 / NEMA 6				
Circuit Protection	Outputs short circuit and over current protected, Vs reverse polarity protected				
Test Input	0V: light source off; Vs or no connection: light source on (only for emitter of thru-beam mode)				
Ambient Operating Temperature	-25°C...55°C				
Storage Temperature	-40°C...70°C				
EMC	IEC 60947-5-2, Parts 7.2.6.1., 2.3 or RFI>3V/m(in 30-1000MHz), EFT>1KV, ESD>4KV(contact)				
Voltage With Stand Ability	IEC 60947-5-2, Part 8.3.3.4 or 500VDC for one min, between all supply terminals connected together and enclosure				
Insulation Resistance	>20M Ω , with 500V DC megger between all supply terminals connected together and enclosure				
Vibration Resistance	IEC 60947-5-2, Part 7.4.2 or 10-55HZ, 1.0mm amplitude in x , y and z directions for 30 min				
Shock Resistance	IEC 60947-5-2, Part 7.4.1 or 30g, 11ms in x , y and z directions for six time each				
Mounting Bracket	MB-3832 (optional)				
Weight	approx. 25g connector versions; 66g cable versions				
Pigtail type	See Pigtail Series or our Cables & Connectors catalogue.				

Note: Used with RE-6152 (supplied with sensor) reflector.

Connection Diagrams

Emitter of Thru-beam Mode

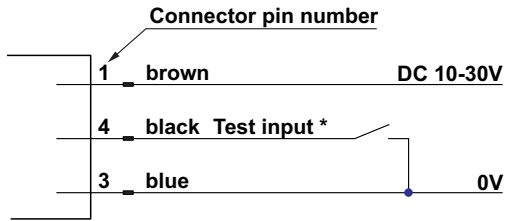

*: Test input=0V Emitter off.

Connector face view
Pico-Style



- 1. Brown (+)
- 2. Not used
- 3. Blue (-)
- 4. Black (Test input)

PNP output type

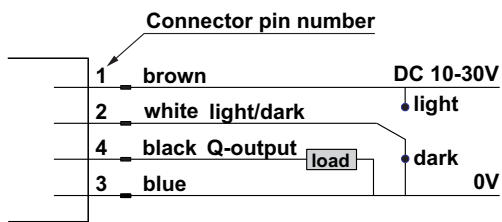

Connector face view
Pico-Style



- 1. Brown (+)
- 2. White (Light/Dark control)
- 3. Blue (-)
- 4. Black (Output)

NPN output type

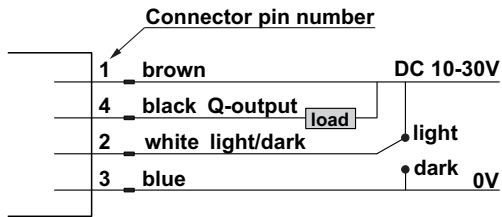

Connector face view
Pico-Style



- 1. Brown (+)
- 2. White (Light/Dark control)
- 3. Blue (-)
- 4. Black (Output)

Sensing Characteristics (Typical)

Diffuse Mode (Sn=400mm)

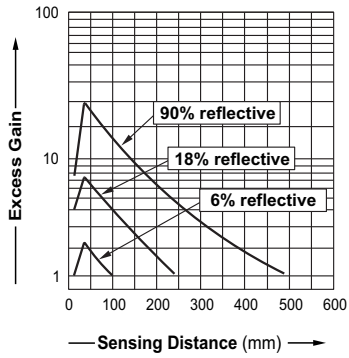

Excess gain curve

Fixed-focus Diffuse Mode (Sn=90mm)

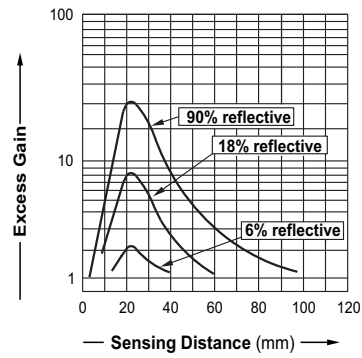

Excess gain curve

Polarized Retroreflective Mode (Sn=4m)

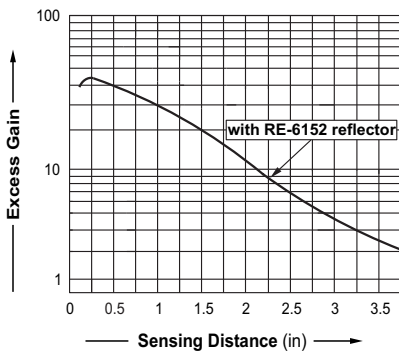

Excess gain curve

Clear Material Sensor (Sn=0.5m)

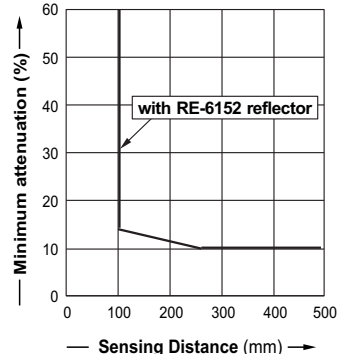

Attenuation curve

Thru-beam Mode (Sn=8.5 m)

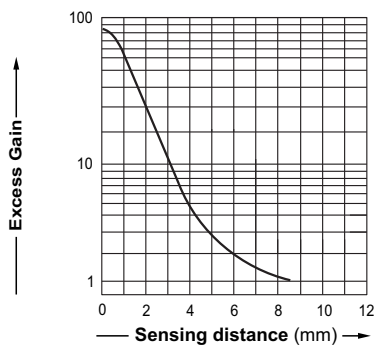

Excess gain curve

Dimensions (Unit: mm)

Sensor Type

Cable Type

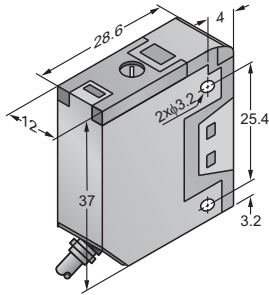

Connector Type (Pico-style)

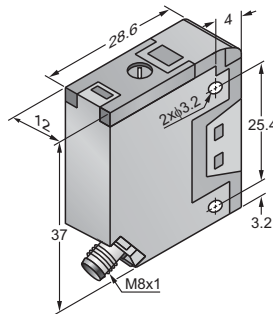

Pigtail* Type (Pico-style)

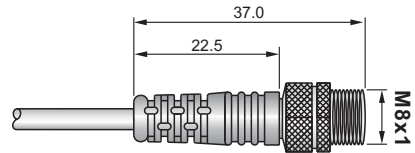

*: Please see **Pigtail Series** or our **Cables & Connectors** catalogue for more information.

MB-3832 (Mounting bracket-optional)

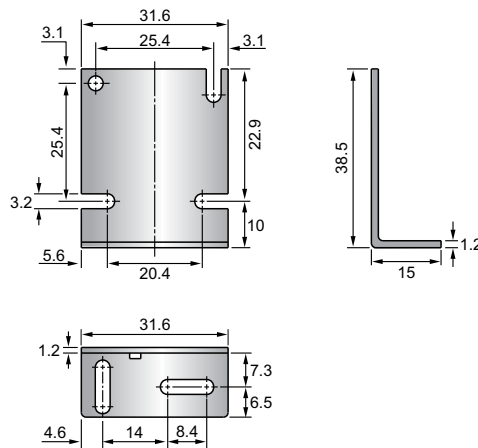

PB-5139 (Protective bracket-optional)

PB-6539 (Protective bracket-optional)

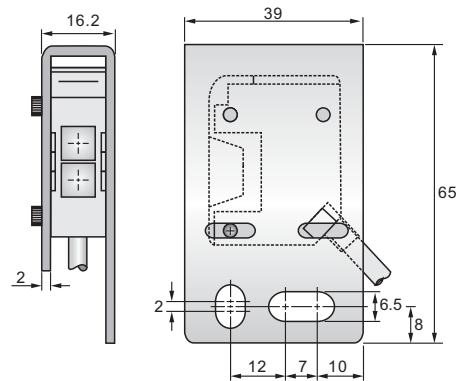
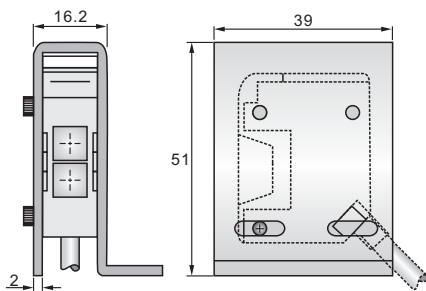
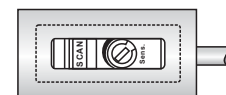
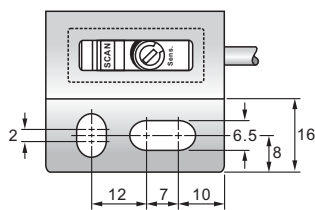

Ac: RP32 SERIES