









Thru-beam Mode (Plastic Housing)

Sensing Mode	Connection	Supply Voltage	Output Mode	Part Number
Infrared: 950 nm  Thru-beam Mode Sensing Distance: 200m	2m Cable 	10-30V DC	Emitter	<u>M30P-T200MD-EX9C2L2</u>
			NPN L.O./D.O.	<u>M30P-T200MN-CX9C4U2</u>
			PNP L.O./D.O.	<u>M30P-T200MP-CX9C4U2</u>
			NPN/PNP L.O./D.O.	<u>M30P-T200MD-CX9C4U2</u>
		20-250V AC	Emitter (2-wire)	<u>M30P-T200MA-EX9C2L2</u>
			Light Operate (2-wire)	<u>M30P-T200MA-LX9C2U2</u>
			Dark Operate (2-wire)	<u>M30P-T200MA-DX9C2U2</u>
			Light Operate (3-wire)	<u>M30P-T200MA-LX9C3U2</u>
		12-240V DC / 24-240V AC	Dark Operate (3-wire)	<u>M30P-T200MA-DX9C3U2</u>
			Emitter (2-wire)	<u>M30P-T200MC-EX9C2L2</u>
			Light Operate (2-wire)	<u>M30P-T200MC-LX9C2U2</u>
			Dark Operate (2-wire)	<u>M30P-T200MC-DX9C2U2</u>
	9m Cable 	10-30V DC	Emitter	<u>M30P-T200MD-EX9C2L9</u>
			NPN L.O./D.O.	<u>M30P-T200MN-CX9C4U9</u>
			PNP L.O./D.O.	<u>M30P-T200MP-CX9C4U9</u>
			NPN/PNP L.O./D.O.	<u>M30P-T200MD-CX9C4U9</u>
		20-250V AC	Emitter (2-wire)	<u>M30P-T200MA-EX9C2L9</u>
			Light Operate (2-wire)	<u>M30P-T200MA-LX9C2U9</u>
			Dark Operate (2-wire)	<u>M30P-T200MA-DX9C2U9</u>
			Light Operate (3-wire)	<u>M30P-T200MA-LX9C3U9</u>
		12-240V DC / 24-240V AC	Dark Operate (3-wire)	<u>M30P-T200MA-DX9C3U9</u>
			Emitter (2-wire)	<u>M30P-T200MC-EX9C2L9</u>
			Light Operate (2-wire)	<u>M30P-T200MC-LX9C2U9</u>
			Dark Operate (2-wire)	<u>M30P-T200MC-DX9C2U9</u>
Quick Disconnect 	10-30V DC (Euro-style)	Emitter	<u>M30P-T200MD-EX9Q4LE</u>	
		NPN L.O./D.O.	<u>M30P-T200MN-CX9Q4UE</u>	
		PNP L.O./D.O.	<u>M30P-T200MP-CX9Q4UE</u>	
		NPN/PNP L.O./D.O.	<u>M30P-T200MD-CX9Q4UE</u>	
	20-250V AC (Micro-style)	Emitter (2-wire)	<u>M30P-T200MA-EX9Q4LM</u>	
		Light Operate (2-wire)	<u>M30P-T200MA-LX9Q4/2UM</u>	
		Dark Operate (2-wire)	<u>M30P-T200MA-DX9Q4/2UM</u>	
		Light Operate (3-wire)	<u>M30P-T200MA-LX9Q4UM</u>	
	12-240V DC / 24-240V AC (Micro-style)	Dark Operate (3-wire)	<u>M30P-T200MA-DX9Q4UM</u>	
		Emitter (2-wire)	<u>M30P-T200MC-EX9Q4LM</u>	
		Light Operate (2-wire)	<u>M30P-T200MC-LX9Q4UM</u>	
		Dark Operate (2-wire)	<u>M30P-T200MC-DX9Q4UM</u>	
6" Pigtail 	10-30V DC (Euro-style)	Emitter	<u>M30P-T200MD-EX9P4LE</u>	
		NPN L.O./D.O.	<u>M30P-T200MN-CX9P4UE</u>	
		PNP L.O./D.O.	<u>M30P-T200MP-CX9P4UE</u>	
		NPN/PNP L.O./D.O.	<u>M30P-T200MD-CX9P4UE</u>	
	20-250V AC (Micro-style)	Emitter (2-wire)	<u>M30P-T200MA-EX9P4LM</u>	
		Light Operate (2-wire)	<u>M30P-T200MA-LX9P4/2UM</u>	
		Dark Operate (2-wire)	<u>M30P-T200MA-DX9P4/2UM</u>	
		Light Operate (3-wire)	<u>M30P-T200MA-LX9P4UM</u>	
	12-240V DC / 24-240V AC (Micro-style)	Dark Operate (3-wire)	<u>M30P-T200MA-DX9P4UM</u>	
		Emitter (2-wire)	<u>M30P-T200MC-EX9P4LM</u>	
		Light Operate (2-wire)	<u>M30P-T200MC-LX9P4UM</u>	
		Dark Operate (2-wire)	<u>M30P-T200MC-DX9P4UM</u>	

Note:
 Coming Soon : Part numbers with underline
 In Preparation: Part numbers with a line through the middle

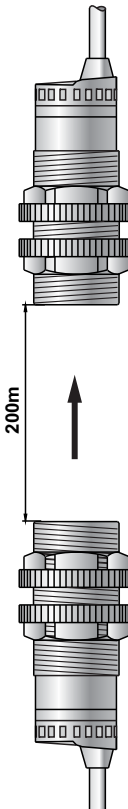



I: M30 SERIES

Thru-beam Mode (Brass Housing)

Sensing Mode	Connection	Supply Voltage	Output Mode	Part Number
<p>Infrared: 950 nm</p>  <p>200m</p> <p>Thru-beam Mode Sensing Distance: 200m</p>	<p>2m Cable</p> 	10-30V DC	Emitter	<u>M30B-T200MD-EX9C2L2</u>
			NPN L.O./D.O.	<u>M30B-T200MN-CX9C4U2</u>
			PNP L.O./D.O.	<u>M30B-T200MP-CX9C4U2</u>
			NPN/PNP L.O./D.O.	<u>M30B-T200MD-CX9C4U2</u>
		20-250V AC	Emitter (2-wire)	<u>M30B-T200MA-EX9C2L2</u>
			Light Operate (2-wire)	<u>M30B-T200MA-LX9C2U2</u>
			Dark Operate (2-wire)	<u>M30B-T200MA-DX9C2U2</u>
			Light Operate (3-wire)	<u>M30B-T200MA-LX9C3U2</u>
		12-240V DC/ 24-240V AC	Dark Operate (3-wire)	<u>M30B-T200MA-DX9C3U2</u>
			Emitter (2-wire)	<u>M30B-T200MC-EX9C2L2</u>
			Light Operate (2-wire)	<u>M30B-T200MC-LX9C2U2</u>
			Dark Operate (2-wire)	<u>M30B-T200MC-DX9C2U2</u>
	<p>9m Cable</p> 	10-30V DC	Emitter	<u>M30B-T200MD-EX9C2L9</u>
			NPN L.O./D.O.	<u>M30B-T200MN-CX9C4U9</u>
			PNP L.O./D.O.	<u>M30B-T200MP-CX9C4U9</u>
			NPN/PNP L.O./D.O.	<u>M30B-T200MD-CX9C4U9</u>
		20-250V AC	Emitter (2-wire)	<u>M30B-T200MA-EX9C2L9</u>
			Light Operate (2-wire)	<u>M30B-T200MA-LX9C2U9</u>
			Dark Operate (2-wire)	<u>M30B-T200MA-DX9C2U9</u>
			Light Operate (3-wire)	<u>M30B-T200MA-LX9C3U9</u>
		12-240V DC/ 24-240V AC	Dark Operate (3-wire)	<u>M30B-T200MA-DX9C3U9</u>
			Emitter (2-wire)	<u>M30B-T200MC-EX9C2L9</u>
			Light Operate (2-wire)	<u>M30B-T200MC-LX9C2U9</u>
			Dark Operate (2-wire)	<u>M30B-T200MC-DX9C2U9</u>
<p>Quick Disconnect</p> 	10-30V DC (Euro-style)	Emitter	<u>M30B-T200MD-EX9Q4LE</u>	
		NPN L.O./D.O.	<u>M30B-T200MN-CX9Q4UE</u>	
		PNP L.O./D.O.	<u>M30B-T200MP-CX9Q4UE</u>	
		NPN/PNP L.O./D.O.	<u>M30B-T200MD-CX9Q4UE</u>	
	20-250V AC (Micro-style)	Emitter (2-wire)	<u>M30B-T200MA-EX9Q4LM</u>	
		Light Operate (2-wire)	<u>M30B-T200MA-LX9Q42UM</u>	
		Dark Operate (2-wire)	<u>M30B-T200MA-DX9Q42UM</u>	
		Light Operate (3-wire)	<u>M30B-T200MA-LX9Q4UM</u>	
	12-240V DC/ 24-240V AC (Micro-style)	Dark Operate (3-wire)	<u>M30B-T200MA-DX9Q4UM</u>	
		Emitter (2-wire)	<u>M30B-T200MC-EX9Q4LM</u>	
		Light Operate (2-wire)	<u>M30B-T200MC-LX9Q4UM</u>	
		Dark Operate (2-wire)	<u>M30B-T200MC-DX9Q4UM</u>	
<p>6" Pigtail</p> 	10-30V DC (Euro-style)	Emitter	<u>M30B-T200MD-EX9P4LE</u>	
		NPN L.O./D.O.	<u>M30B-T200MN-CX9P4UE</u>	
		PNP L.O./D.O.	<u>M30B-T200MP-CX9P4UE</u>	
		NPN/PNP L.O./D.O.	<u>M30B-T200MD-CX9P4UE</u>	
	20-250V AC (Micro-style)	Emitter (2-wire)	<u>M30B-T200MA-EX9P4LM</u>	
		Light Operate (2-wire)	<u>M30B-T200MA-LX9P42UM</u>	
		Dark Operate (2-wire)	<u>M30B-T200MA-DX9P42UM</u>	
		Light Operate (3-wire)	<u>M30B-T200MA-LX9P4UM</u>	
	12-240V DC/ 24-240V AC (Micro-style)	Dark Operate (3-wire)	<u>M30B-T200MA-DX9P4UM</u>	
		Emitter (2-wire)	<u>M30B-T200MC-EX9P4LM</u>	
		Light Operate (2-wire)	<u>M30B-T200MC-LX9P4UM</u>	
		Dark Operate (2-wire)	<u>M30B-T200MC-DX9P4UM</u>	

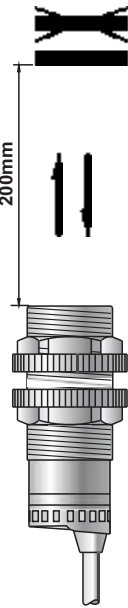





Note:
 Coming Soon : Part numbers with underline
 In Preparation: Part numbers with a line through the middle

Diffuse Mode with Background Suppression (Sn=200mm, Plastic Housing)

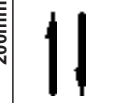
Sensing Mode	Connection	Supply Voltage	Output Mode	Part Number
Infrared: 880 nm  Diffuse Mode with Background Suppression Sensing Distance: 200mm	2m Cable 	10-30V DC	NPN L.O./D.O.	<u>M30P-D0200N-CX9C4U2-BS</u>
			PNP L.O./D.O.	<u>M30P-D0200P-CX9C4U2-BS</u>
			NPN/PNP L.O./D.O.	<u>M30P-D0200D-CX9C4U2-BS</u>
		20-250V AC	Light Operate (2-wire)	<u>M30P-D0200A-LX9C2U2-BS</u>
			Dark Operate (2-wire)	<u>M30P-D0200A-DX9C2U2-BS</u>
			Light Operate (3-wire)	<u>M30P-D0200A-LX9C3U2-BS</u>
			Dark Operate (3-wire)	<u>M30P-D0200A-DX9C3U2-BS</u>
		12-240V DC / 24-240V AC	Light Operate (2-wire)	<u>M30P-D0200C-LX9C2U2-BS</u>
			Dark Operate (2-wire)	<u>M30P-D0200C-DX9C2U2-BS</u>
	9m Cable 	10-30V DC	NPN L.O./D.O.	<u>M30P-D0200N-CX9C4U9-BS</u>
			PNP L.O./D.O.	<u>M30P-D0200P-CX9C4U9-BS</u>
			NPN/PNP L.O./D.O.	<u>M30P-D0200D-CX9C4U9-BS</u>
		20-250V AC	Light Operate (2-wire)	<u>M30P-D0200A-LX9C2U9-BS</u>
			Dark Operate (2-wire)	<u>M30P-D0200A-DX9C2U9-BS</u>
			Light Operate (3-wire)	<u>M30P-D0200A-LX9C3U9-BS</u>
			Dark Operate (3-wire)	<u>M30P-D0200A-DX9C3U9-BS</u>
		12-240V DC / 24-240V AC	Light Operate (2-wire)	<u>M30P-D0200C-LX9C2U9-BS</u>
			Dark Operate (2-wire)	<u>M30P-D0200C-DX9C2U9-BS</u>
	Quick Disconnect 	10-30V DC (Euro-style)	NPN L.O./D.O.	<u>M30P-D0200N-CX9Q4UE-BS</u>
			PNP L.O./D.O.	<u>M30P-D0200P-CX9Q4UE-BS</u>
			NPN/PNP L.O./D.O.	<u>M30P-D0200D-CX9Q4UE-BS</u>
		20-250V AC (Micro-style)	Light Operate (2-wire)	<u>M30P-D0200A-LX9Q4/2UM-BS</u>
			Dark Operate (2-wire)	<u>M30P-D0200A-DX9Q4/2UM-BS</u>
			Light Operate (3-wire)	<u>M30P-D0200A-LX9Q4UM-BS</u>
Dark Operate (3-wire)			<u>M30P-D0200A-DX9Q4UM-BS</u>	
12-240V DC / 24-240V AC (Micro-style)		Light Operate (2-wire)	<u>M30P-D0200C-LX9Q4UM-BS</u>	
		Dark Operate (2-wire)	<u>M30P-D0200C-DX9Q4UM-BS</u>	
6" Pigtail 		10-30V DC (Euro-style)	NPN L.O./D.O.	<u>M30P-D0200N-CX9P4UE-BS</u>
			PNP L.O./D.O.	<u>M30P-D0200P-CX9P4UE-BS</u>
			NPN/PNP L.O./D.O.	<u>M30P-D0200D-CX9P4UE-BS</u>
	20-250V AC (Micro-style)	Light Operate (2-wire)	<u>M30P-D0200A-LX9P4/2UM-BS</u>	
		Dark Operate (2-wire)	<u>M30P-D0200A-DX9P4/2UM-BS</u>	
		Light Operate (3-wire)	<u>M30P-D0200A-LX9P4UM-BS</u>	
		Dark Operate (3-wire)	<u>M30P-D0200A-DX9P4UM-BS</u>	
	12-240V DC / 24-240V AC (Micro-style)	Light Operate (2-wire)	<u>M30P-D0200C-LX9P4UM-BS</u>	
		Dark Operate (2-wire)	<u>M30P-D0200C-DX9P4UM-BS</u>	





Note:
 Coming Soon : Part numbers with underline
 In Preparation: Part numbers with a line through the middle

Diffuse Mode with Background Suppression (Sn=200mm, Brass Housing)

Sensing Mode	Connection	Supply Voltage	Output Mode	Part Number	
Infrared: 880 nm    Diffuse Mode with Background Suppression Sensing Distance: 200mm	2m Cable 	10-30V DC	NPN L.O./D.O.	<u>M30B-D0200N-CX9C4U2-BS</u>	
			PNP L.O./D.O.	<u>M30B-D0200P-CX9C4U2-BS</u>	
			NPN/PNP L.O./D.O.	<u>M30B-D0200D-CX9C4U2-BS</u>	
		20-250V AC	Light Operate (2-wire)	<u>M30B-D0200A-LX9C2U2-BS</u>	
			Dark Operate (2-wire)	<u>M30B-D0200A-DX9C2U2-BS</u>	
			Light Operate (3-wire)	<u>M30B-D0200A-LX9C3U2-BS</u>	
			Dark Operate (3-wire)	<u>M30B-D0200A-DX9C3U2-BS</u>	
		12-240V DC / 24-240V AC	Light Operate (2-wire)	<u>M30B-D0200C-LX9C2U2-BS</u>	
			Dark Operate (2-wire)	<u>M30B-D0200C-DX9C2U2-BS</u>	
		9m Cable 	10-30V DC	NPN L.O./D.O.	<u>M30B-D0200N-CX9C4U9-BS</u>
				PNP L.O./D.O.	<u>M30B-D0200P-CX9C4U9-BS</u>
				NPN/PNP L.O./D.O.	<u>M30B-D0200D-CX9C4U9-BS</u>
	20-250V AC		Light Operate (2-wire)	<u>M30B-D0200A-LX9C2U9-BS</u>	
			Dark Operate (2-wire)	<u>M30B-D0200A-DX9C2U9-BS</u>	
			Light Operate (3-wire)	<u>M30B-D0200A-LX9C3U9-BS</u>	
			Dark Operate (3-wire)	<u>M30B-D0200A-DX9C3U9-BS</u>	
	12-240V DC / 24-240V AC		Light Operate (2-wire)	<u>M30B-D0200C-LX9C2U9-BS</u>	
			Dark Operate (2-wire)	<u>M30B-D0200C-DX9C2U9-BS</u>	
	Quick Disconnect 		10-30V DC (Euro-style)	NPN L.O./D.O.	<u>M30B-D0200N-CX9Q4UE-BS</u>
				PNP L.O./D.O.	<u>M30B-D0200P-CX9Q4UE-BS</u>
				NPN/PNP L.O./D.O.	<u>M30B-D0200D-CX9Q4UE-BS</u>
		20-250V AC (Micro-style)	Light Operate (2-wire)	<u>M30B-D0200A-LX9Q4/2UM-BS</u>	
			Dark Operate (2-wire)	<u>M30B-D0200A-DX9Q4/2UM-BS</u>	
			Light Operate (3-wire)	<u>M30B-D0200A-LX9Q4UM-BS</u>	
Dark Operate (3-wire)			<u>M30B-D0200A-DX9Q4UM-BS</u>		
12-240V DC / 24-240V AC (Micro-style)		Light Operate (2-wire)	<u>M30B-D0200C-LX9Q4UM-BS</u>		
		Dark Operate (2-wire)	<u>M30B-D0200C-DX9Q4UM-BS</u>		
6" Pigtail 		10-30V DC (Euro-style)	NPN L.O./D.O.	<u>M30B-D0200N-CX9P4UE-BS</u>	
			PNP L.O./D.O.	<u>M30B-D0200P-CX9P4UE-BS</u>	
			NPN/PNP L.O./D.O.	<u>M30B-D0200D-CX9P4UE-BS</u>	
	20-250V AC (Micro-style)	Light Operate (2-wire)	<u>M30B-D0200A-LX9P4/2UM-BS</u>		
		Dark Operate (2-wire)	<u>M30B-D0200A-DX9P4/2UM-BS</u>		
		Light Operate (3-wire)	<u>M30B-D0200A-LX9P4UM-BS</u>		
		Dark Operate (3-wire)	<u>M30B-D0200A-DX9P4UM-BS</u>		
	12-240V DC / 24-240V AC (Micro-style)	Light Operate (2-wire)	<u>M30B-D0200C-LX9P4UM-BS</u>		
		Dark Operate (2-wire)	<u>M30B-D0200C-DX9P4UM-BS</u>		

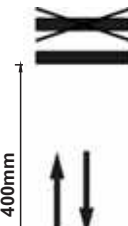



Note:
 Coming Soon : Part numbers with underline
 In Preparation: Part numbers with a line through the middle

Diffuse Mode with Background Suppression (Sn=400mm, Plastic Housing)

Sensing Mode	Connection	Supply Voltage	Output Mode	Part Number	
Infrared: 880 nm  Diffuse Mode with Background Suppression Sensing Distance: 400mm	2m Cable 	10-30V DC	NPN L.O./D.O.	<u>M30P-D0400N-CX9C4U2-BS</u>	
			PNP L.O./D.O.	<u>M30P-D0400P-CX9C4U2-BS</u>	
			NPN/PNP L.O./D.O.	<u>M30P-D0400D-CX9C4U2-BS</u>	
		20-250V AC	Light Operate (2-wire)	<u>M30P-D0400A-LX9G2U2-BS</u>	
			Dark Operate (2-wire)	<u>M30P-D0400A-DX9G2U2-BS</u>	
			Light Operate (3-wire)	<u>M30P-D0400A-LX9G3U2-BS</u>	
			Dark Operate (3-wire)	<u>M30P-D0400A-DX9G3U2-BS</u>	
		12-240V DC / 24-240V AC	Light Operate (2-wire)	<u>M30P-D0400C-LX9G2U2-BS</u>	
			Dark Operate (2-wire)	<u>M30P-D0400C-DX9G2U2-BS</u>	
		9m Cable 	10-30V DC	NPN L.O./D.O.	<u>M30P-D0400N-CX9C4U9-BS</u>
				PNP L.O./D.O.	<u>M30P-D0400P-CX9C4U9-BS</u>
				NPN/PNP L.O./D.O.	<u>M30P-D0400D-CX9C4U9-BS</u>
	20-250V AC		Light Operate (2-wire)	<u>M30P-D0400A-LX9C2U9-BS</u>	
			Dark Operate (2-wire)	<u>M30P-D0400A-DX9C2U9-BS</u>	
			Light Operate (3-wire)	<u>M30P-D0400A-LX9C3U9-BS</u>	
			Dark Operate (3-wire)	<u>M30P-D0400A-DX9C3U9-BS</u>	
	12-240V DC / 24-240V AC		Light Operate (2-wire)	<u>M30P-D0400C-LX9C2U9-BS</u>	
			Dark Operate (2-wire)	<u>M30P-D0400C-DX9C2U9-BS</u>	
	Quick Disconnect 		10-30V DC (Euro-style)	NPN L.O./D.O.	<u>M30P-D0400N-CX9Q4UE-BS</u>
				PNP L.O./D.O.	<u>M30P-D0400P-CX9Q4UE-BS</u>
				NPN/PNP L.O./D.O.	<u>M30P-D0400D-CX9Q4UE-BS</u>
		20-250V AC (Micro-style)	Light Operate (2-wire)	<u>M30P-D0400A-LX9Q4/2UM-BS</u>	
			Dark Operate (2-wire)	<u>M30P-D0400A-DX9Q4/2UM-BS</u>	
			Light Operate (3-wire)	<u>M30P-D0400A-LX9Q4UM-BS</u>	
Dark Operate (3-wire)			<u>M30P-D0400A-DX9Q4UM-BS</u>		
12-240V DC / 24-240V AC (Micro-style)		Light Operate (2-wire)	<u>M30P-D0400C-LX9Q4UM-BS</u>		
		Dark Operate (2-wire)	<u>M30P-D0400C-DX9Q4UM-BS</u>		
6" Pigtail 		10-30V DC (Euro-style)	NPN L.O./D.O.	<u>M30P-D0400N-CX9P4UE-BS</u>	
			PNP L.O./D.O.	<u>M30P-D0400P-CX9P4UE-BS</u>	
			NPN/PNP L.O./D.O.	<u>M30P-D0400D-CX9P4UE-BS</u>	
	20-250V AC (Micro-style)	Light Operate (2-wire)	<u>M30P-D0400A-LX9P4/2UM-BS</u>		
		Dark Operate (2-wire)	<u>M30P-D0400A-DX9P4/2UM-BS</u>		
		Light Operate (3-wire)	<u>M30P-D0400A-LX9P4UM-BS</u>		
		Dark Operate (3-wire)	<u>M30P-D0400A-DX9P4UM-BS</u>		
	12-240V DC / 24-240V AC (Micro-style)	Light Operate (2-wire)	<u>M30P-D0400C-LX9P4UM-BS</u>		
		Dark Operate (2-wire)	<u>M30P-D0400C-DX9P4UM-BS</u>		

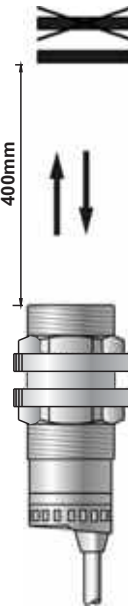





Note:
 Coming Soon : Part numbers with underline
 In Preparation: Part numbers with a line through the middle

Diffuse Mode with Background Suppression (Sn=400mm, Brass Housing)

Sensing Mode	Connection	Supply Voltage	Output Mode	Part Number	
Infrared: 880 nm  400mm Diffuse Mode with Background Suppression Sensing Distance: 400mm	2m Cable 	10-30V DC	NPN L.O./D.O.	<u>M30B-D0400N-CX9C4U2-BS</u>	
			PNP L.O./D.O.	<u>M30B-D0400P-CX9C4U2-BS</u>	
			NPN/PNP L.O./D.O.	<u>M30B-D0400D-CX9C4U2-BS</u>	
		20-250V AC	Light Operate (2-wire)	<u>M30B-D0400A-LX9C2U2-BS</u>	
			Dark Operate (2-wire)	<u>M30B-D0400A-DX9C2U2-BS</u>	
			Light Operate (3-wire)	<u>M30B-D0400A-LX9C3U2-BS</u>	
			Dark Operate (3-wire)	<u>M30B-D0400A-DX9C3U2-BS</u>	
		12-240V DC/ 24-240V AC	Light Operate (2-wire)	<u>M30B-D0400C-LX9C2U2-BS</u>	
			Dark Operate (2-wire)	<u>M30B-D0400C-DX9C2U2-BS</u>	
		9m Cable 	10-30V DC	NPN L.O./D.O.	<u>M30B-D0400N-CX9C4U9-BS</u>
				PNP L.O./D.O.	<u>M30B-D0400P-CX9C4U9-BS</u>
				NPN/PNP L.O./D.O.	<u>M30B-D0400D-CX9C4U9-BS</u>
	20-250V AC		Light Operate (2-wire)	<u>M30B-D0400A-LX9C2U9-BS</u>	
			Dark Operate (2-wire)	<u>M30B-D0400A-DX9C2U9-BS</u>	
			Light Operate (3-wire)	<u>M30B-D0400A-LX9C3U9-BS</u>	
			Dark Operate (3-wire)	<u>M30B-D0400A-DX9C3U9-BS</u>	
	12-240V DC/ 24-240V AC		Light Operate (2-wire)	<u>M30B-D0400C-LX9C2U9-BS</u>	
			Dark Operate (2-wire)	<u>M30B-D0400C-DX9C2U9-BS</u>	
	Quick Disconnect 		10-30V DC (Euro-style)	NPN L.O./D.O.	<u>M30B-D0400N-CX9Q4UE-BS</u>
				PNP L.O./D.O.	<u>M30B-D0400P-CX9Q4UE-BS</u>
				NPN/PNP L.O./D.O.	<u>M30B-D0400D-CX9Q4UE-BS</u>
		20-250V AC (Micro-style)	Light Operate (2-wire)	<u>M30B-D0400A-LX9Q4/2UM-BS</u>	
			Dark Operate (2-wire)	<u>M30B-D0400A-DX9Q4/2UM-BS</u>	
			Light Operate (3-wire)	<u>M30B-D0400A-LX9Q4UM-BS</u>	
Dark Operate (3-wire)			<u>M30B-D0400A-DX9Q4UM-BS</u>		
12-240V DC/ 24-240V AC (Micro-style)		Light Operate (2-wire)	<u>M30B-D0400C-LX9Q4UM-BS</u>		
		Dark Operate (2-wire)	<u>M30B-D0400C-DX9Q4UM-BS</u>		
6" Pigtail 		10-30V DC (Euro-style)	NPN L.O./D.O.	<u>M30B-D0400N-CX9P4UE-BS</u>	
			PNP L.O./D.O.	<u>M30B-D0400P-CX9P4UE-BS</u>	
			NPN/PNP L.O./D.O.	<u>M30B-D0400D-CX9P4UE-BS</u>	
	20-250V AC (Micro-style)	Light Operate (2-wire)	<u>M30B-D0400A-LX9P4/2UM-BS</u>		
		Dark Operate (2-wire)	<u>M30B-D0400A-DX9P4/2UM-BS</u>		
		Light Operate (3-wire)	<u>M30B-D0400A-LX9P4UM-BS</u>		
		Dark Operate (3-wire)	<u>M30B-D0400A-DX9P4UM-BS</u>		
	12-240V DC/ 24-240V AC (Micro-style)	Light Operate (2-wire)	<u>M30B-D0400C-LX9P4UM-BS</u>		
		Dark Operate (2-wire)	<u>M30B-D0400C-DX9P4UM-BS</u>		





Note:
 Coming Soon : Part numbers with underline
 In Preparation: Part numbers with a line through the middle

Diffuse Mode with Background Suppression (Sn=600mm, Plastic Housing)

Sensing Mode	Connection	Supply Voltage	Output Mode	Part Number	
Infrared: 880 nm    Diffuse Mode with Background Suppression Sensing Distance: 600mm	2m Cable 	10-30V DC	NPN L.O./D.O.	<u>M30P-D0600N-CX9C4U2-BS</u>	
			PNP L.O./D.O.	<u>M30P-D0600P-CX9C4U2-BS</u>	
			NPN/PNP L.O./D.O.	<u>M30P-D0600D-CX9C4U2-BS</u>	
		20-250V AC	Light Operate (2-wire)	<u>M30P-D0600A-LX9C2U2-BS</u>	
			Dark Operate (2-wire)	<u>M30P-D0600A-DX9C2U2-BS</u>	
			Light Operate (3-wire)	<u>M30P-D0600A-LX9C3U2-BS</u>	
			Dark Operate (3-wire)	<u>M30P-D0600A-DX9C3U2-BS</u>	
		12-240V DC / 24-240V AC	Light Operate (2-wire)	<u>M30P-D0600C-LX9C2U2-BS</u>	
			Dark Operate (2-wire)	<u>M30P-D0600C-DX9C2U2-BS</u>	
		9m Cable 	10-30V DC	NPN L.O./D.O.	<u>M30P-D0600N-CX9C4U9-BS</u>
				PNP L.O./D.O.	<u>M30P-D0600P-CX9C4U9-BS</u>
				NPN/PNP L.O./D.O.	<u>M30P-D0600D-CX9C4U9-BS</u>
	20-250V AC		Light Operate (2-wire)	<u>M30P-D0600A-LX9C2U9-BS</u>	
			Dark Operate (2-wire)	<u>M30P-D0600A-DX9C2U9-BS</u>	
			Light Operate (3-wire)	<u>M30P-D0600A-LX9C3U9-BS</u>	
			Dark Operate (3-wire)	<u>M30P-D0600A-DX9C3U9-BS</u>	
	12-240V DC / 24-240V AC		Light Operate (2-wire)	<u>M30P-D0600C-LX9C2U9-BS</u>	
			Dark Operate (2-wire)	<u>M30P-D0600C-DX9C2U9-BS</u>	
	Quick Disconnect 		10-30V DC (Euro-style)	NPN L.O./D.O.	<u>M30P-D0600N-CX9Q4UE-BS</u>
				PNP L.O./D.O.	<u>M30P-D0600P-CX9Q4UE-BS</u>
				NPN/PNP L.O./D.O.	<u>M30P-D0600D-CX9Q4UE-BS</u>
		20-250V AC (Micro-style)	Light Operate (2-wire)	<u>M30P-D0600A-LX9Q4/2UM-BS</u>	
			Dark Operate (2-wire)	<u>M30P-D0600A-DX9Q4/2UM-BS</u>	
			Light Operate (3-wire)	<u>M30P-D0600A-LX9Q4UM-BS</u>	
Dark Operate (3-wire)			<u>M30P-D0600A-DX9Q4UM-BS</u>		
12-240V DC / 24-240V AC (Micro-style)		Light Operate (2-wire)	<u>M30P-D0600C-LX9Q4UM-BS</u>		
		Dark Operate (2-wire)	<u>M30P-D0600C-DX9Q4UM-BS</u>		
6" Pigtail 		10-30V DC (Euro-style)	NPN L.O./D.O.	<u>M30P-D0600N-CX9P4UE-BS</u>	
			PNP L.O./D.O.	<u>M30P-D0600P-CX9P4UE-BS</u>	
			NPN/PNP L.O./D.O.	<u>M30P-D0600D-CX9P4UE-BS</u>	
	20-250V AC (Micro-style)	Light Operate (2-wire)	<u>M30P-D0600A-LX9P4/2UM-BS</u>		
		Dark Operate (2-wire)	<u>M30P-D0600A-DX9P4/2UM-BS</u>		
		Light Operate (3-wire)	<u>M30P-D0600A-LX9P4UM-BS</u>		
		Dark Operate (3-wire)	<u>M30P-D0600A-DX9P4UM-BS</u>		
	12-240V DC / 24-240V AC (Micro-style)	Light Operate (2-wire)	<u>M30P-D0600C-LX9P4UM-BS</u>		
		Dark Operate (2-wire)	<u>M30P-D0600C-DX9P4UM-BS</u>		





Note:
 Coming Soon : Part numbers with underline
 In Preparation: Part numbers with a line through the middle

Diffuse Mode with Background Suppression (Sn=600mm, Brass Housing)

Sensing Mode	Connection	Supply Voltage	Output Mode	Part Number	
Infrared: 880 nm  Diffuse Mode with Background Suppression Sensing Distance: 600mm	2m Cable 	10-30V DC	NPN L.O./D.O.	<u>M30B-D0600N-CX9C4U2-BS</u>	
			PNP L.O./D.O.	<u>M30B-D0600P-CX9C4U2-BS</u>	
			NPN/PNP L.O./D.O.	<u>M30B-D0600D-CX9C4U2-BS</u>	
		20-250V AC	Light Operate (2-wire)	<u>M30B-D0600A-LX9C2U2-BS</u>	
			Dark Operate (2-wire)	<u>M30B-D0600A-DX9C2U2-BS</u>	
			Light Operate (3-wire)	<u>M30B-D0600A-LX9C3U2-BS</u>	
			Dark Operate (3-wire)	<u>M30B-D0600A-DX9C3U2-BS</u>	
		12-240V DC / 24-240V AC	Light Operate (2-wire)	<u>M30B-D0600C-LX9C2U2-BS</u>	
			Dark Operate (2-wire)	<u>M30B-D0600C-DX9C2U2-BS</u>	
		9m Cable 	10-30V DC	NPN L.O./D.O.	<u>M30B-D0600N-CX9C4U9-BS</u>
				PNP L.O./D.O.	<u>M30B-D0600P-CX9C4U9-BS</u>
				NPN/PNP L.O./D.O.	<u>M30B-D0600D-CX9C4U9-BS</u>
	20-250V AC		Light Operate (2-wire)	<u>M30B-D0600A-LX9C2U9-BS</u>	
			Dark Operate (2-wire)	<u>M30B-D0600A-DX9C2U9-BS</u>	
			Light Operate (3-wire)	<u>M30B-D0600A-LX9C3U9-BS</u>	
			Dark Operate (3-wire)	<u>M30B-D0600A-DX9C3U9-BS</u>	
	12-240V DC / 24-240V AC		Light Operate (2-wire)	<u>M30B-D0600C-LX9C2U9-BS</u>	
			Dark Operate (2-wire)	<u>M30B-D0600C-DX9C2U9-BS</u>	
	Quick Disconnect 		10-30V DC (Euro-style)	NPN L.O./D.O.	<u>M30B-D0600N-CX9Q4UE-BS</u>
				PNP L.O./D.O.	<u>M30B-D0600P-CX9Q4UE-BS</u>
				NPN/PNP L.O./D.O.	<u>M30B-D0600D-CX9Q4UE-BS</u>
		20-250V AC (Micro-style)	Light Operate (2-wire)	<u>M30B-D0600A-LX9Q4/2UM-BS</u>	
			Dark Operate (2-wire)	<u>M30B-D0600A-DX9Q4/2UM-BS</u>	
			Light Operate (3-wire)	<u>M30B-D0600A-LX9Q4UM-BS</u>	
Dark Operate (3-wire)			<u>M30B-D0600A-DX9Q4UM-BS</u>		
12-240V DC / 24-240V AC (Micro-style)		Light Operate (2-wire)	<u>M30B-D0600C-LX9Q4UM-BS</u>		
		Dark Operate (2-wire)	<u>M30B-D0600C-DX9Q4UM-BS</u>		
6" Pigtail 		10-30V DC (Euro-style)	NPN L.O./D.O.	<u>M30B-D0600N-CX9P4UE-BS</u>	
			PNP L.O./D.O.	<u>M30B-D0600P-CX9P4UE-BS</u>	
			NPN/PNP L.O./D.O.	<u>M30B-D0600D-CX9P4UE-BS</u>	
	20-250V AC (Micro-style)	Light Operate (2-wire)	<u>M30B-D0600A-LX9P4/2UM-BS</u>		
		Dark Operate (2-wire)	<u>M30B-D0600A-DX9P4/2UM-BS</u>		
		Light Operate (3-wire)	<u>M30B-D0600A-LX9P4UM-BS</u>		
		Dark Operate (3-wire)	<u>M30B-D0600A-DX9P4UM-BS</u>		
	12-240V DC / 24-240V AC (Micro-style)	Light Operate (2-wire)	<u>M30B-D0600C-LX9P4UM-BS</u>		
		Dark Operate (2-wire)	<u>M30B-D0600C-DX9P4UM-BS</u>		

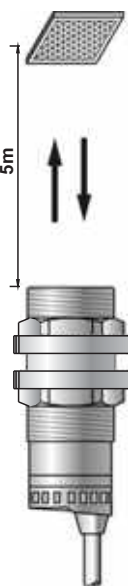



Note:
 Coming Soon : Part numbers with underline
 In Preparation: Part numbers with a line through the middle

Retroreflective Mode with Polarizing Filter (Plastic Housing)

Sensing Mode	Connection	Supply Voltage	Output Mode	Part Number	
<p>Visible red: 680 nm</p>  <p>5m</p> <p>Retro-reflective Mode with Polarizing Filter Sensing Distance: 5m (Note)</p>	<p>2m Cable</p> 	10-30V DC	NPN L.O./D.O.	M30P-L5000N-CX6C4U2-PF	
			PNP L.O./D.O.	M30P-L5000P-CX6C4U2-PF	
			NPN/PNP L.O./D.O.	<u>M30P-L5000D-CX6C4U2-PF</u>	
		20-250V AC	Light Operate (2-wire)	<u>M30P-L5000A-LX6G2U2-PF</u>	
			Dark Operate (2-wire)	<u>M30P-L5000A-DX6G2U2-PF</u>	
			Light Operate (3-wire)	<u>M30P-L5000A-LX6G3U2-PF</u>	
			Dark Operate (3-wire)	<u>M30P-L5000A-DX6G3U2-PF</u>	
		12-240V DC/ 24-240V AC	Light Operate (2-wire)	<u>M30P-L5000C-LX6G2U2-PF</u>	
			Dark Operate (2-wire)	<u>M30P-L5000C-DX6G2U2-PF</u>	
		<p>9m Cable</p> 	10-30V DC	NPN L.O./D.O.	M30P-L5000N-CX6C4U9-PF
				PNP L.O./D.O.	M30P-L5000P-CX6C4U9-PF
				NPN/PNP L.O./D.O.	<u>M30P-L5000D-CX6C4U9-PF</u>
	20-250V AC		Light Operate (2-wire)	<u>M30P-L5000A-LX6G2U9-PF</u>	
			Dark Operate (2-wire)	<u>M30P-L6000A-DX6G2U9-PF</u>	
			Light Operate (3-wire)	<u>M30P-L5000A-LX6G3U9-PF</u>	
			Dark Operate (3-wire)	<u>M30P-L5000A-DX6G3U9-PF</u>	
	12-240V DC/ 24-240V AC		Light Operate (2-wire)	<u>M30P-L5000C-LX6G2U9-PF</u>	
			Dark Operate (2-wire)	<u>M30P-L5000C-DX6G2U9-PF</u>	
	<p>Quick Disconnect</p> 		10-30V DC (Euro-style)	NPN L.O./D.O.	M30P-L5000N-CX6Q4UE-PF
				PNP L.O./D.O.	M30P-L5000P-CX6Q4UE-PF
				NPN/PNP L.O./D.O.	<u>M30P-L5000D-CX6Q4UE-PF</u>
		20-250V AC (Micro-style)	Light Operate (2-wire)	<u>M30P-L5000A-LX6Q4/2UM-PF</u>	
			Dark Operate (2-wire)	<u>M30P-L5000A-DX6Q4/2UM-PF</u>	
			Light Operate (3-wire)	<u>M30P-L5000A-LX6Q4UM-PF</u>	
Dark Operate (3-wire)			<u>M30P-L5000A-DX6Q4UM-PF</u>		
12-240V DC/ 24-240V AC (Micro-style)		Light Operate (2-wire)	<u>M30P-L5000C-LX6Q4UM-PF</u>		
		Dark Operate (2-wire)	<u>M30P-L5000C-DX6Q4UM-PF</u>		
<p>6" Pigtail</p> 		10-30V DC (Euro-style)	NPN L.O./D.O.	M30P-L5000N-CX6P4UE-PF	
			PNP L.O./D.O.	M30P-L5000P-CX6P4UE-PF	
			NPN/PNP L.O./D.O.	<u>M30P-L5000D-CX6P4UE-PF</u>	
	20-250V AC (Micro-style)	Light Operate (2-wire)	<u>M30P-L5000A-LX6P4/2UM-PF</u>		
		Dark Operate (2-wire)	<u>M30P-L5000A-DX6P4/2UM-PF</u>		
		Light Operate (3-wire)	<u>M30P-L5000A-LX6P4UM-PF</u>		
		Dark Operate (3-wire)	<u>M30P-L5000A-DX6P4UM-PF</u>		
	12-240V DC/ 24-240V AC (Micro-style)	Light Operate (2-wire)	<u>M30P-L5000C-LX6P4UM-PF</u>		
		Dark Operate (2-wire)	<u>M30P-L5000C-DX6P4UM-PF</u>		







Note: Used with RE-D82 (supplied with sensor) reflector.
 Coming Soon : Part numbers with underline
 In Preparation: Part numbers with a line through the middle

Retroreflective Mode with Polarizing Filter (Brass Housing)

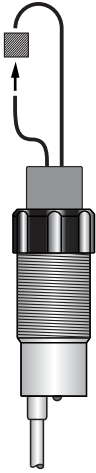
Sensing Mode	Connection	Supply Voltage	Output Mode	Part Number	
Retro-reflective Mode with Polarizing Filter Sensing Distance: 5m (Note)	2m Cable 	10-30V DC	NPN L.O./D.O.	<u>M30B-L5000N-CX6C4U2-PF</u>	
			PNP L.O./D.O.	<u>M30B-L5000P-CX6C4U2-PF</u>	
			NPN/PNP L.O./D.O.	<u>M30B-L5000D-CX6C4U2-PF</u>	
		20-250V AC	Light Operate (2-wire)	<u>M30B-L5000A-LX6G2U2-PF</u>	
			Dark Operate (2-wire)	<u>M30B-L5000A-DX6G2U2-PF</u>	
			Light Operate (3-wire)	<u>M30B-L5000A-LX6G3U2-PF</u>	
			Dark Operate (3-wire)	<u>M30B-L5000A-DX6G3U2-PF</u>	
		12-240V DC/24-240V AC	Light Operate (2-wire)	<u>M30B-L5000C-LX6G2U2-PF</u>	
			Dark Operate (2-wire)	<u>M30B-L5000C-DX6G2U2-PF</u>	
		9m Cable 	10-30V DC	NPN L.O./D.O.	<u>M30B-L5000N-CX6C4U9-PF</u>
				PNP L.O./D.O.	<u>M30B-L5000P-CX6C4U9-PF</u>
				NPN/PNP L.O./D.O.	<u>M30B-L5000D-CX6C4U9-PF</u>
	20-250V AC		Light Operate (2-wire)	<u>M30B-L5000A-LX6C2U9-PF</u>	
			Dark Operate (2-wire)	<u>M30B-L5000A-DX6C2U9-PF</u>	
			Light Operate (3-wire)	<u>M30B-L5000A-LX6C3U9-PF</u>	
			Dark Operate (3-wire)	<u>M30B-L5000A-DX6C3U9-PF</u>	
	12-240V DC/24-240V AC		Light Operate (2-wire)	<u>M30B-L5000C-LX6C2U9-PF</u>	
			Dark Operate (2-wire)	<u>M30B-L5000C-DX6C2U9-PF</u>	
	Quick Disconnect 		10-30V DC (Euro-style)	NPN L.O./D.O.	<u>M30B-L5000N-CX6Q4UE-PF</u>
				PNP L.O./D.O.	<u>M30B-L5000P-CX6Q4UE-PF</u>
				NPN/PNP L.O./D.O.	<u>M30B-L5000D-CX6Q4UE-PF</u>
		20-250V AC (Micro-style)	Light Operate (2-wire)	<u>M30B-L5000A-LX6Q4/2UM-PF</u>	
			Dark Operate (2-wire)	<u>M30B-L5000A-DX6Q4/2UM-PF</u>	
			Light Operate (3-wire)	<u>M30B-L5000A-LX6Q4UM-PF</u>	
Dark Operate (3-wire)			<u>M30B-L5000A-DX6Q4UM-PF</u>		
12-240V DC/24-240V AC (Micro-style)		Light Operate (2-wire)	<u>M30B-L5000C-LX6Q4UM-PF</u>		
		Dark Operate (2-wire)	<u>M30B-L5000C-DX6Q4UM-PF</u>		
6" Pigtail 		10-30V DC (Euro-style)	NPN L.O./D.O.	<u>M30B-L5000N-CX6P4UE-PF</u>	
			PNP L.O./D.O.	<u>M30B-L5000P-CX6P4UE-PF</u>	
			NPN/PNP L.O./D.O.	<u>M30B-L5000D-CX6P4UE-PF</u>	
	20-250V AC (Micro-style)	Light Operate (2-wire)	<u>M30B-L5000A-LX6P4/2UM-PF</u>		
		Dark Operate (2-wire)	<u>M30B-L5000A-DX6P4/2UM-PF</u>		
		Light Operate (3-wire)	<u>M30B-L5000A-LX6P4UM-PF</u>		
		Dark Operate (3-wire)	<u>M30B-L5000A-DX6P4UM-PF</u>		
	12-240V DC/24-240V AC (Micro-style)	Light Operate (2-wire)	<u>M30B-L5000C-LX6P4UM-PF</u>		
		Dark Operate (2-wire)	<u>M30B-L5000C-DX6P4UM-PF</u>		



Note: Used with RE-D82 (supplied with sensor) reflector.
 Coming Soon : Part numbers with underline
 In Preparation: Part numbers with a line through the middle

Glass Fiber Optic (Thru-beam Mode, Plastic Housing)

Sensing Mode	Connection	Supply Voltage	Output Mode	Part Number
Infrared LED  Glass Fiber Optic (Thru-beam Mode) Sensing Distance (Note)	2m Cable  	10-30V DC	NPN L.O./D.O.	<u>M30P-TGFN-CX9G4U2</u>
			PNP L.O./D.O.	<u>M30P-TGFP-CX9G4U2</u>
			NPN/PNP L.O./D.O.	<u>M30P-TGFD-CX9G4U2</u>
		20-250V AC	Light-ON (2-wire)	<u>M30P-TGFA-LX9G2U2</u>
			Dark-ON (2-wire)	<u>M30P-TGFA-DX9G2U2</u>
			Light-ON (3-wire)	<u>M30P-TGFA-LX9G3U2</u>
			Dark-ON (3-wire)	<u>M30P-TGFA-DX9G3U2</u>
		12-240V DC/ 24-240V AC	Light-ON (2-wire)	<u>M30P-TGFC-LX9G2U2</u>
			Dark-ON (2-wire)	<u>M30P-TGFC-DX9G2U2</u>
	Quick Disconnect  	10-30V DC (Euro-style)	NPN L.O./D.O.	<u>M30P-TGFN-CX9Q4UE</u>
			PNP L.O./D.O.	<u>M30P-TGFP-CX9Q4UE</u>
			NPN/PNP L.O./D.O.	<u>M30P-TGFD-CX9Q4UE</u>
		20-250V AC (Micro-style)	Light-ON (2-wire)	<u>M30P-TGFA-LX9Q4/2UM</u>
			Dark-ON (2-wire)	<u>M30P-TGFA-DX9Q4/2UM</u>
			Light-ON (3-wire)	<u>M30P-TGFA-LX9Q4UM</u>
Dark-ON (3-wire)			<u>M30P-TGFA-DX9Q4UM</u>	
12-240V DC/ 24-240V AC (Micro-style)		Light-ON (2-wire)	<u>M30P-TGFC-LX9Q4UM</u>	
		Dark-ON (2-wire)	<u>M30P-TGFC-DX9Q4UM</u>	
6" Pig tail  	10-30V DC (Euro-style)	NPN L.O./D.O.	<u>M30P-TGFN-CX9P4UE</u>	
		PNP L.O./D.O.	<u>M30P-TGFP-CX9P4UE</u>	
		NPN/PNP L.O./D.O.	<u>M30P-TGFD-CX9P4UE</u>	
	20-250V AC (Micro-style)	Light-ON (2-wire)	<u>M30P-TGFA-LX9P4/2UM</u>	
		Dark-ON (2-wire)	<u>M30P-TGFA-DX9P4/2UM</u>	
		Light-ON (3-wire)	<u>M30P-TGFA-LX9P4UM</u>	
		Dark-ON (3-wire)	<u>M30P-TGFA-DX9P4UM</u>	
	12-240V DC/ 24-240V AC (Micro-style)	Light-ON (2-wire)	<u>M30P-TGFC-LX9P4UM</u>	
		Dark-ON (2-wire)	<u>M30P-TGFC-DX9P4UM</u>	

Note: Coming Soon : Part numbers with underline
 In Preparation: Part numbers with a line through the middle
 Depends on fiber optic used (Please see our **Glass Fiber & Plastic Fiber** catalogue for detail information).





Glass Fiber Optic (Thru-beam Mode, Brass Housing)

Sensing Mode	Connection	Supply Voltage	Output Mode	Part Number		
Infrared LED		10-30V DC	NPN L.O./D.O.	<u>M30B-TGFN-CX9G4U2</u>		
			PNP L.O./D.O.	<u>M30B-TGFP-CX9G4U2</u>		
			NPN/PNP L.O./D.O.	<u>M30B-TGFD-CX9G4U2</u>		
		20-250V AC	Light-ON (2-wire)	<u>M30B-TGFA-LX9G2U2</u>		
			Dark-ON (2-wire)	<u>M30B-TGFA-DX9G2U2</u>		
			Light-ON (3-wire)	<u>M30B-TGFA-LX9G3U2</u>		
			Dark-ON (3-wire)	<u>M30B-TGFA-DX9G3U2</u>		
		12-240V DC/ 24-240V AC	Light-ON (2-wire)	<u>M30B-TGFC-LX9G2U2</u>		
			Dark-ON (2-wire)	<u>M30B-TGFC-DX9G2U2</u>		
		Glass Fiber Optic (Thru-beam Mode) Sensing Distance (Note)		10-30V DC (Euro-style)	NPN L.O./D.O.	<u>M30B-TGFN-CX9Q4UE</u>
					PNP L.O./D.O.	<u>M30B-TGFP-CX9Q4UE</u>
					NPN/PNP L.O./D.O.	<u>M30B-TGFD-CX9Q4UE</u>
20-250V AC (Micro-style)	Light-ON (2-wire)			<u>M30B-TGFA-LX9Q4/2UM</u>		
	Dark-ON (2-wire)			<u>M30B-TGFA-DX9Q4/2UM</u>		
	Light-ON (3-wire)			<u>M30B-TGFA-LX9Q4UM</u>		
	Dark-ON (3-wire)			<u>M30B-TGFA-DX9Q4UM</u>		
12-240V DC/ 24-240V AC (Micro-style)	Light-ON (2-wire)			<u>M30B-TGFC-LX9Q4UM</u>		
	Dark-ON (2-wire)			<u>M30B-TGFC-DX9Q4UM</u>		
Glass Fiber Optic (Thru-beam Mode) Sensing Distance (Note)				10-30V DC (Euro-style)	NPN L.O./D.O.	<u>M30B-TGFN-CX9P4UE</u>
					PNP L.O./D.O.	<u>M30B-TGFP-CX9P4UE</u>
					NPN/PNP L.O./D.O.	<u>M30B-TGFD-CX9P4UE</u>
		20-250V AC (Micro-style)	Light-ON (2-wire)	<u>M30B-TGFA-LX9P4/2UM</u>		
			Dark-ON (2-wire)	<u>M30B-TGFA-DX9P4/2UM</u>		
			Light-ON (3-wire)	<u>M30B-TGFA-LX9P4UM</u>		
			Dark-ON (3-wire)	<u>M30B-TGFA-DX9P4UM</u>		
		12-240V DC/ 24-240V AC (Micro-style)	Light-ON (2-wire)	<u>M30B-TGFC-LX9P4UM</u>		
			Dark-ON (2-wire)	<u>M30B-TGFC-DX9P4UM</u>		

Note: Coming Soon : Part numbers with underline
 In Preparation: Part numbers with a line through the middle
 Depends on fiber optic used (Please see our Glass Fiber & Plastic Fiber catalogue for detail information).







I: M30 SERIES

Glass Fiber Optic (Diffuse Mode, Plastic Housing)

Sensing Mode	Connection	Supply Voltage	Output Mode	Part Number	
Infrared LED  Glass Fiber Optic (Diffuse Mode) Sensing Distance (Note)	2m Cable  CE	10-30V DC	NPN L.O./D.O.	<u>M30P-DGFN-CX9C4U2</u>	
			PNP L.O./D.O.	<u>M30P-DGFP-CX9C4U2</u>	
			NPN/PNP L.O./D.O.	<u>M30P-DGFD-CX9C4U2</u>	
		20-250V AC	Light-ON (2-wire)	<u>M30P-DGFA-LX9C2U2</u>	
			Dark-ON (2-wire)	<u>M30P-DGFA-DX9C2U2</u>	
			Light-ON (3-wire)	<u>M30P-DGFA-LX9C3U2</u>	
			Dark-ON (3-wire)	<u>M30P-DGFA-DX9C3U2</u>	
		12-240V DC/ 24-240V AC	Light-ON (2-wire)	<u>M30P-DGFC-LX9C2U2</u>	
			Dark-ON (2-wire)	<u>M30P-DGFC-DX9C2U2</u>	
		Quick Disconnect  CE	10-30V DC (Euro-style)	NPN L.O./D.O.	<u>M30P-DGFN-CX9Q4UE</u>
				PNP L.O./D.O.	<u>M30P-DGFP-CX9Q4UE</u>
				NPN/PNP L.O./D.O.	<u>M30P-DGFD-CX9Q4UE</u>
	20-250V AC (Micro-style)		Light-ON (2-wire)	<u>M30P-DGFA-LX9Q4/2UM</u>	
			Dark-ON (2-wire)	<u>M30P-DGFA-DX9Q4/2UM</u>	
			Light-ON (3-wire)	<u>M30P-DGFA-LX9Q4UM</u>	
			Dark-ON (3-wire)	<u>M30P-DGFA-DX9Q4UM</u>	
	12-240V DC/ 24-240V AC (Micro-style)		Light-ON (2-wire)	<u>M30P-DGFC-LX9Q4UM</u>	
			Dark-ON (2-wire)	<u>M30P-DGFC-DX9Q4UM</u>	
6" Pig tail  CE	10-30V DC (Euro-style)		NPN L.O./D.O.	<u>M30P-DGFN-CX9P4UE</u>	
			PNP L.O./D.O.	<u>M30P-DGFP-CX9P4UE</u>	
			NPN/PNP L.O./D.O.	<u>M30P-DGFD-CX9P4UE</u>	
	20-250V AC (Micro-style)	Light-ON (2-wire)	<u>M30P-DGFA-LX9P4/2UM</u>		
		Dark-ON (2-wire)	<u>M30P-DGFA-DX9P4/2UM</u>		
		Light-ON (3-wire)	<u>M30P-DGFA-LX9P4UM</u>		
		Dark-ON (3-wire)	<u>M30P-DGFA-DX9P4UM</u>		
	12-240V DC/ 24-240V AC (Micro-style)	Light-ON (2-wire)	<u>M30P-DGFC-LX9P4UM</u>		
		Dark-ON (2-wire)	<u>M30P-DGFC-DX9P4UM</u>		

Note: Coming Soon : Part numbers with underline
 In Preparation: Part numbers with a line through the middle
 Depends on fiber optic used (Please see our Glass Fiber & Plastic Fiber catalogue for detail information).

Glass Fiber Optic (Diffuse Mode, Brass Housing)

Sensing Mode	Connection	Supply Voltage	Output Mode	Part Number
Infrared LED  Glass Fiber Optic (Diffuse Mode) Sensing Distance (Note)	2m Cable  	10-30V DC	NPN L.O./D.O.	<u>M30B-DGFN-CX9C4U2</u>
			PNP L.O./D.O.	<u>M30B-DGFP-CX9C4U2</u>
			NPN/PNP L.O./D.O.	<u>M30B-DGFD-CX9C4U2</u>
		20-250V AC	Light-ON (2-wire)	<u>M30B-DGFA-LX9C2U2</u>
			Dark-ON (2-wire)	<u>M30B-DGFA-DX9C2U2</u>
			Light-ON (3-wire)	<u>M30B-DGFA-LX9C3U2</u>
			Dark-ON (3-wire)	<u>M30B-DGFA-DX9C3U2</u>
		12-240V DC/ 24-240V AC	Light-ON (2-wire)	<u>M30B-DGFC-LX9C2U2</u>
			Dark-ON (2-wire)	<u>M30B-DGFC-DX9C2U2</u>
	Quick Disconnect  	10-30V DC (Euro-style)	NPN L.O./D.O.	<u>M30B-DGFN-CX9Q4UE</u>
			PNP L.O./D.O.	<u>M30B-DGFP-CX9Q4UE</u>
			NPN/PNP L.O./D.O.	<u>M30B-DGFD-CX9Q4UE</u>
		20-250V AC (Micro-style)	Light-ON (2-wire)	<u>M30B-DGFA-LX9Q4/2UM</u>
			Dark-ON (2-wire)	<u>M30B-DGFA-DX9Q4/2UM</u>
			Light-ON (3-wire)	<u>M30B-DGFA-LX9Q4UM</u>
			Dark-ON (3-wire)	<u>M30B-DGFA-DX9Q4UM</u>
		12-240V DC/ 24-240V AC (Micro-style)	Light-ON (2-wire)	<u>M30B-DGFC-LX9Q4UM</u>
			Dark-ON (2-wire)	<u>M30B-DGFC-DX9Q4UM</u>
6" Pig tail  	10-30V DC (Euro-style)	NPN L.O./D.O.	<u>M30B-DGFN-CX9P4UE</u>	
		PNP L.O./D.O.	<u>M30B-DGFP-CX9P4UE</u>	
		NPN/PNP L.O./D.O.	<u>M30B-DGFD-CX9P4UE</u>	
	20-250V AC (Micro-style)	Light-ON (2-wire)	<u>M30B-DGFA-LX9P4/2UM</u>	
		Dark-ON (2-wire)	<u>M30B-DGFA-DX9P4/2UM</u>	
		Light-ON (3-wire)	<u>M30B-DGFA-LX9P4UM</u>	
		Dark-ON (3-wire)	<u>M30B-DGFA-DX9P4UM</u>	
	12-240V DC/ 24-240V AC (Micro-style)	Light-ON (2-wire)	<u>M30B-DGFC-LX9P4UM</u>	
		Dark-ON (2-wire)	<u>M30B-DGFC-DX9P4UM</u>	

Note: Coming Soon : Part numbers with underline
 In Preparation: Part numbers with a line through the middle
 Depends on fiber optic used (Please see our Glass Fiber & Plastic Fiber catalogue for detail information).

I: M30 SERIES

Specifications (DC)

Supply Voltage	10 - 30V DC (10% maximum ripple)
Current Consumption (no load)	<30 mA
Supply Protection Circuitry	Protected against reverse polarity and transient voltages
Output Protection Circuitry	Protected against false pulse on power-up and continuous overload or short circuit of outputs
Construction	Housing are thermoplastic polyester; Lenses are acrylic
Environmental Rating	IEC IP67 / NEMA 6P
Repeatability	Thru-beam: 375 microseconds; Polarized Retro, Non-Polarized Retro, Fixed-field and Diffuse modes: 750 microseconds.
Operating Temperature	Temperature: -40° to +70°C Maximum relative humidity: 90% at 50 °C (non-condensing)
Output Rating	150mA max.; When wired for alarm output, the total load may not exceed 150 mA; Off-state leakage current : <1 microamp at 30V DC; On-state saturation voltage: <1V @10 mA DC; <1.5V @ 150 mA DC
Output Response Time	Thru-beam: 3 milliseconds "on", 1.5 milliseconds "off"; Polarized Retro, Non-Polarized Retro, Fixed-field and Diffuse: 3 milliseconds "on" and "off" NOTE:100 millisecond delay on power-up; outputs are non-conducting during this time
Output Configuration	SPDT (complementary) solid-state dc switch; choose NPN or PNP models. Light Operate: N.O. output conducts when the sensor sees its own modulated light Dark Operate: N.C. output conducts when the sensor sees dark; the N.C. output may be wired as a normally open marginal signal alarm output, depending hookup to the power supply.
Indicators	Two LEDs: Green and Yellow GREEN glowing steadily = power to sensor is "on" YELLOW glowing steadily = normally open output is conducting
EMC	IEC 60947-5-2, Parts 7.2.6.1. 2. 3 or RFI>3V/m(in 30-1000MHZ), EFT>1KV, ESD>4KV(contact)
Voltage Withstand Ability	IEC 60947-5-2, Part 8.3.3.4 or 1500VAC for one min, between all supply terminals connected together and enclosure
Insulation Resistance	>20M Ω , with 1500V AC megger between all supply terminals connected together and enclosure
Vibration Resistance	IEC 60947-5-2, Part 7.4.2 or 10-55HZ, 1.0mm amplitude in x , y and z directions for 30 min
Shock Resistance	IEC 60947-5-2, Part 7.4.1 or 30g, 11ms in x , y and z directions for six time each
Connections	2 m (6.5 ft) or 9 m (30 ft) attached cable, or 4-pin Euro-style connector or pig-tail
Pigtail Type	See Pigtail Series or our Cables & Connectors catalogue.

Specifications (AC)

Supply Voltage	20 - 250V AC(50/60 Hz)
Current Consumption(no load)	<1.8 mA
Supply Protection Circuitry	Protected against transient voltages
Output Protection Circuitry	Protected against false pulse on power-up
Construction	Housing are thermoplastic polyester; Lenses are acrylic
Environmental Rating	IEC IP67 / NEMA 6P
Repeatability	Thru-beam: 2 microseconds; Polarized Retro, Non-Polarized Retro, Fixed-field and Diffuse modes: 4 microseconds.
Operating Temperature	Temperature: -40° to +70°C Maximum relative humidity: 90% at 50 °C (non-condensing)
Output Response Time	Thru-beam: 16 milliseconds "on", 8 milliseconds "off"; Polarized Retro, Non-Polarized Retro, Fixed-field and Diffuse: 16 milliseconds "on" and "off" NOTE: 100 millisecond delay on power-up
Output Configuration	SPST solid-state AC switch; 2-wire hookup; choose light operate or dark operate mode: Light Operate Models: Output conducts when the sensor sees its own (or the emitter's) modulated light Dark Operate Models: Output conducts when sensor sees dark
Output Rating	300mA maximum Fixed-field models: derate 5 mA/°C above +50 °C (122 °C); Inrush capability: 1 amp for 20 milliseconds, non-repetitive Off-state leakage: current<1.8mA On-state voltage drop: 3V @ 300mA AC; 2V @ 15 mA AC
Indicators	Two LEDs: Green and Yellow GREEN glowing steadily = power to sensor is "on" GREEN flashing = output is overloaded (dc models only) YELLOW glowing steadily = normally open output is conducting
EMC	IEC 60947-5-2, Parts 7.2.6.1. 2. 3 or RFI>3V/m(in 30-1000MHZ), EFT>1KV, ESD>4KV(contact)
Voltage Withstand Ability	IEC 60947-5-2, Part 8.3.3.4 or 1500VAC for one min, between all supply terminals connected together and enclosure
Insulation Resistance	>20M Ω , with 1500V AC megger between all supply terminals connected together and enclosure
Vibration Resistance	IEC 60947-5-2, Part 7.4.2 or 10-55HZ, 1.0mm amplitude in x , y and z directions for 30 min
Shock Resistance	IEC 60947-5-2, Part 7.4.1 or 30g, 11ms in x , y and z directions for six time each
Connections	2 m (6.5 ft) or 9 m (30 ft) attached cable, or 4-pin micro-style or pig-tail
Pigtail Type	See Pigtail Series or our Cables & Connectors catalogue.

Specifications (AC/DC)

Supply Voltage	12-240V DC / 24-240V AC
Current Consumption(no load)	<1.8 mA @ AC, <30 mA @ DC
Supply Protection Circuitry	Protected against transient voltages
Output Protection Circuitry	Protected against false pulse on power-up
Construction	Housing are thermoplastic polyester; Lenses are acrylic
Environmental Rating	IEC IP67 / NEMA 6P
Repeatability	Thru-beam: 2 microseconds; Polarized Retro, Non-Polarized Retro, Fixed-field and Diffuse modes: 4 microseconds.
Operating Temperature	Temperature: -40° to +70°C Maximum relative humidity: 90% at 50 °C (non-condensing)
Output Response Time	Thru-beam: 16 milliseconds "on", 8 milliseconds "off"; Polarized Retro, Non-Polarized Retro, Fixed-field and Diffuse: 16 milliseconds "on" and "off" NOTE: 100 millisecond delay on power-up
Output Configuration	SPST solid-state AC switch; 2-wire hookup, choose light operate or dark operate mode; Light Operate Models: Output conducts when the sensor sees its own (or the emitter's) modulated light Dark Operate Models: Output conducts when sensor sees dark
Output Rating	300mA maximum Fixed-field models: derate 5 mA/°C above +50 °C (122 °C); Inrush capability : 1 amp for 20 milliseconds, non-repetitive Off-state leakage current: <1.8mA On-state voltage drop: 3V @ 300mA AC; 2V @ 15mA AC
Indicators	Two LEDs: Green and Yellow GREEN glowing steadily = power to sensor is "on" GREEN flashing = output is overloaded (dc models only) YELLOW glowing steadily = normally open output is conducting
EMC	IEC 60947-5-2, Parts 7.2.6.1. 2. 3 or RFI>3V/m(in 30-1000MHZ), EFT>1KV, ESD>4KV(contact)
Voltage Withstand Ability	IEC 60947-5-2, Part 8.3.3.4 or 1500VAC for one min, between all supply terminals connected together and enclosure
Insulation Resistance	>20MΩ, with 1500V AC megger between all supply terminals connected together and enclosure
Vibration Resistance	IEC 60947-5-2, Part 7.4.2 or 10-55HZ, 1.0mm amplitude in x , y and z directions for 30 min
Shock Resistance	IEC 60947-5-2, Part 7.4.1 or 30g, 11ms in x , y and z directions for six time each
Connections	2 m (6.5 ft) or 9 m (30 ft) attached cable, or 4-pin micro-style or pig-tail
Pig tail Type	See Pigtail Series or our Cables & Connectors catalogue.

Connection Diagrams (AC & AC/DC)

Emitter of Thru-beam Mode (AC)

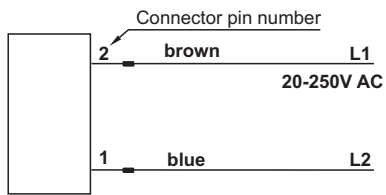

Connector pin position

Micro-style

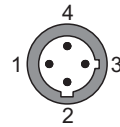

- 1. Blue(L2)
- 2. Brown (L1)
- 3. Not used
- 4. Not used

Receiver of Thru-beam Mode & other mode sensors (AC)

2-wire Type

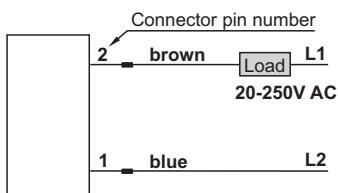

3-wire Type

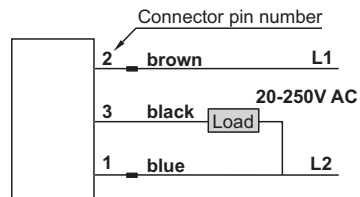

Connector pin position

Micro-style

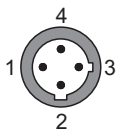

- 1. Blue(L2)
- 2. Brown (L1)
- 3. Not used
- 4. Not used

Connector pin position

Micro-style

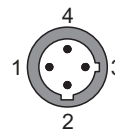

- 1. Blue(L2)
- 2. Brown (L1)
- 3. Black (Output for 3-wire)
- 4. Not used

Emitter of Thru-beam Mode (AC/DC)

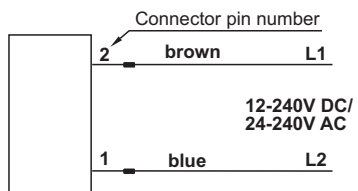

Connector pin position

Micro-style

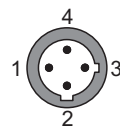

- 1. Blue(L2)
- 2. Brown (L1)
- 3. Not used
- 4. Not used

Receiver of Thru-beam Mode & other mode sensors (AC/DC)

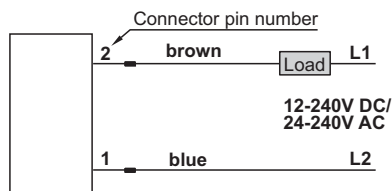

Connector pin position

Micro-style

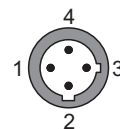

- 1. Blue(L2)
- 2. Brown (L1)
- 3. Not used
- 4. Not used

Connection Diagrams (DC)

Standard NPN output Standard PNP output

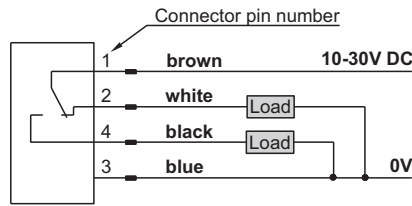
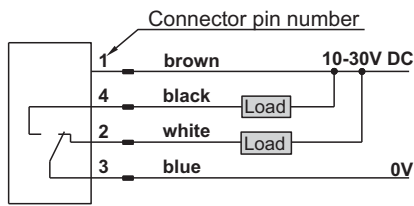

Connector pin position

Euro-style



NPN output with Alarm output PNP output with Alarm output

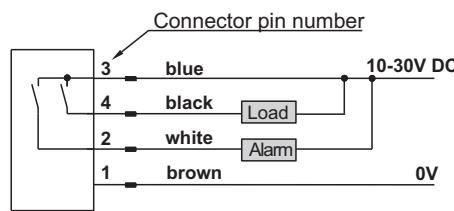
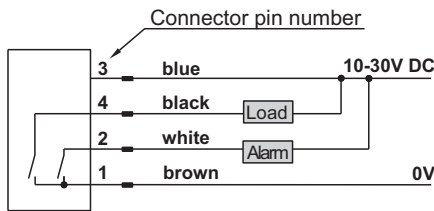

Connector pin position

Euro-style

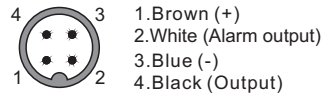

NPN/PNP output type

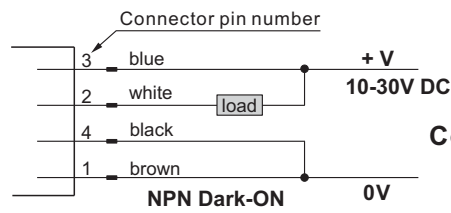
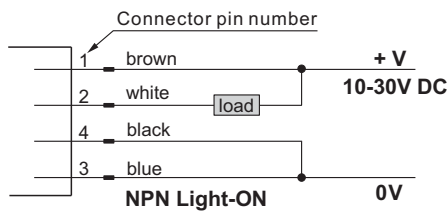

Connector pin position

Euro-style

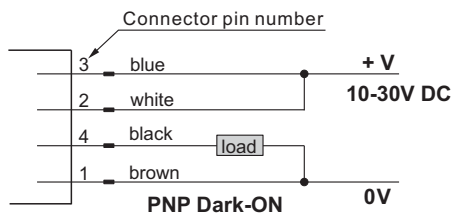
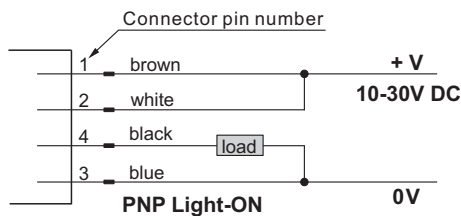
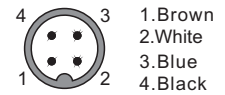

Emitter of Thru-beam Mode

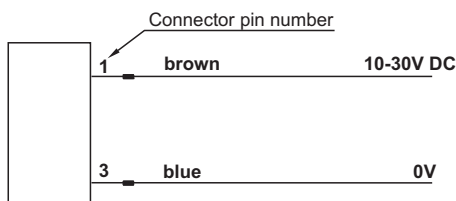

Connector pin position

Euro-style



Sensing Characteristics (Typical)

Diffuse Mode (with background suppression)

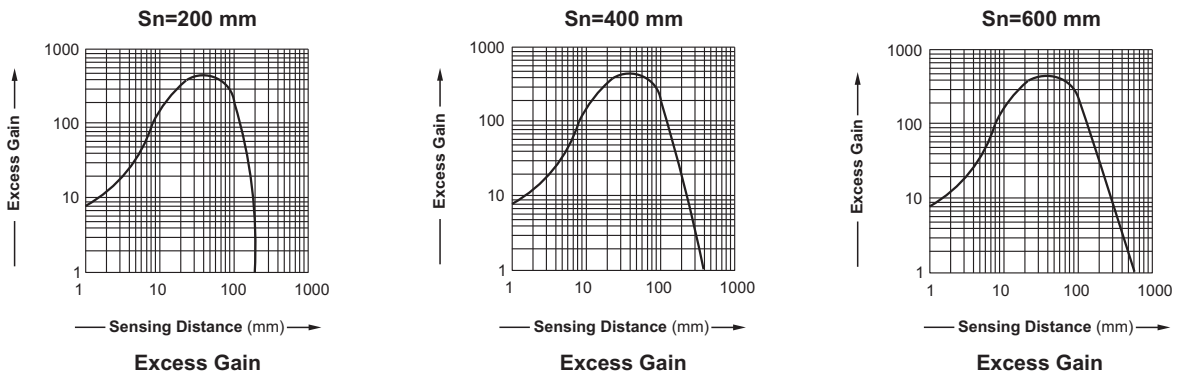

Retroreflective Mode (with polarizing filter)

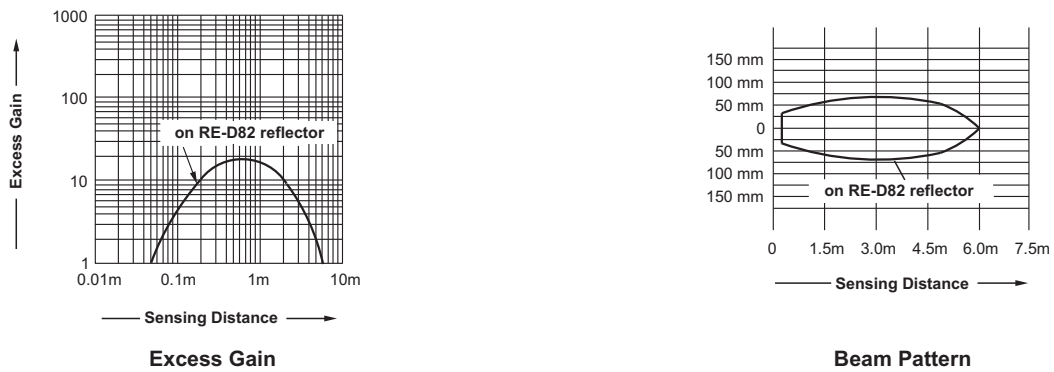

Thru-beam Mode

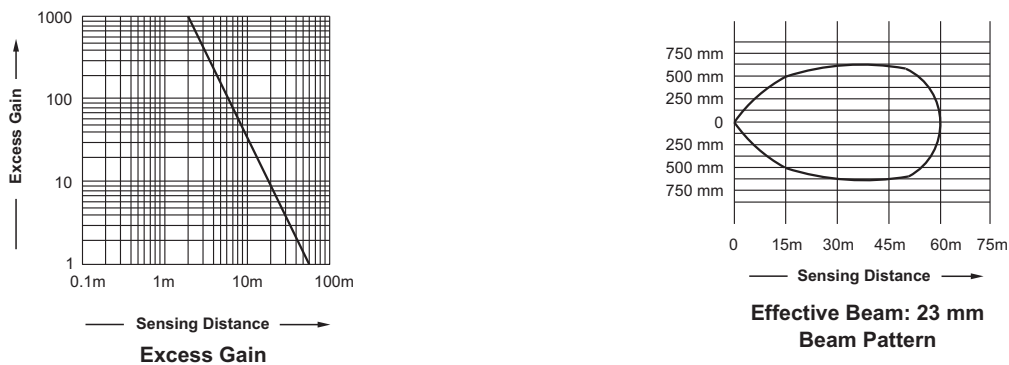

Dimensions (Unit: mm)

Sensor Type

Cable Type

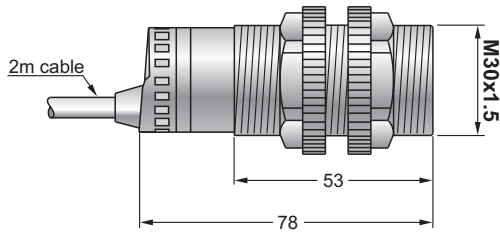

Connector Type

(DC: Euro style; AC: Micro style)

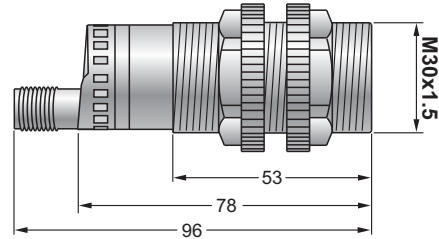

Pigtail* Type

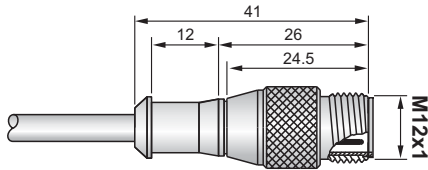

*: Please see **Pigtail Series** or our **Cables & Connectors** catalogue for more information.

Mounting Bracket *

MB-6961 (optional)

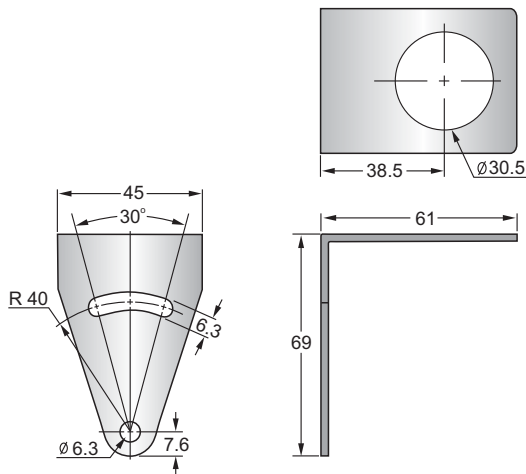

MB-7057 (optional)

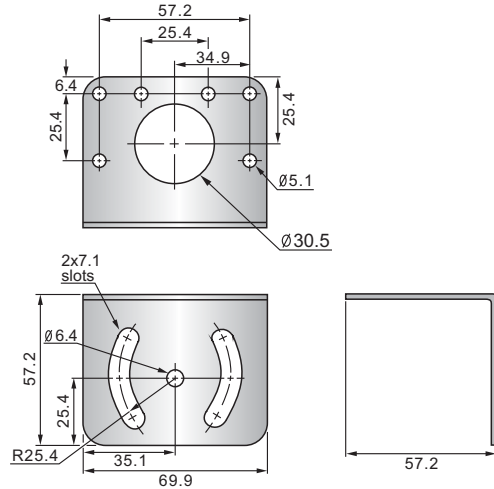

MB-6356 (optional)

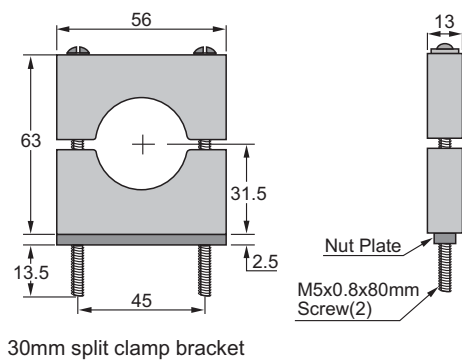

MB-6658 (optional)

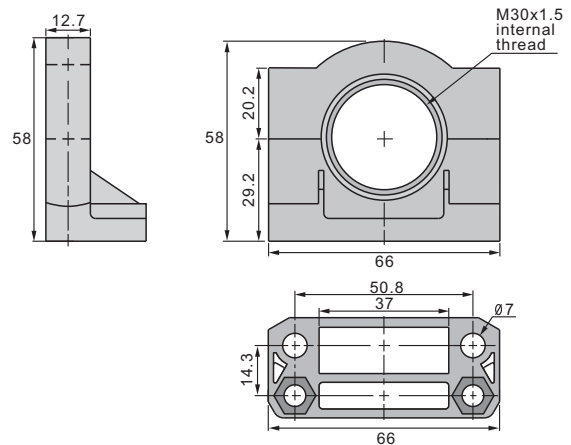

*: Please see **Accessories** (Universal Mounting Brackets Series).

I: M30 SERIES