

Limitless™ Wireless Multi-Protocol Receiver

WMPR Series

002391

Issue 3

Datasheet



DESCRIPTION

The WMPR Series is a reliable DIN Rail or panel-mountable receiver that is designed to receive a wireless signal from a Limitless™ digital or analog input or node. The WMPR Series receiver then communicates the Limitless™ digital or analog node status (i.e., switch open or closed, pressure value) to an EtherNet/IP™ compliant Master device (i.e., programmable logic controller). The WMPR has been tested with “Modbus™ coupler” devices that allow providing a Modbus/TCP output. When compared to traditional wired solutions, Honeywell’s wireless solutions can greatly reduce the costs of wiring, installation, and maintenance by eliminating the need for conduit, connectors, and wire while significantly reducing installation and labor costs.

Accommodating up to 14 Limitless™ digital or analog nodes, the WMPR Series is designed for applications requiring multiple wireless inputs. The WMPR Series receiver is menu driven through the use of function buttons and an easy-to-read LCD. The menu allows the user to see the status of the nodes, configure nodes, and update receiver functionality.

VALUE TO CUSTOMERS

- **Simple navigation:** LCD function buttons on the front panel allow the user to easily navigate through the menu to obtain status of the switch actuation state, sensor value, battery condition, RF signal loss, node pairing, node update rate, fault indications, etc.
- **Cost-effective:** Helps reduce installation and maintenance costs with no wires, conduit, strain relief, clips, connectors, connection boxes, etc.
- **Configurable:** Ability to reconfigure and network multiple interfaces, or point-to-point with personalized addresses, allows for adding, subtracting, or relocating Limitless™ inputs easily

FEATURES

- Visual feedback via LCD: RF signal loss, battery condition, node update rate, node pairing, etc.
- Output is ODVA certified – EtherNet/IP Conformance Tested™
- Ability to produce EtherNet/IP™ and Modbus/TCP (coupler devices required) output
- Can monitor up to 14 Limitless™ digital or analog nodes on a single device
- FCC 15.247 (US), IC RSS 210 (Canada), and ETSI, CE mark (Europe) approvals
- IP20 sealing
- Designed with combination of DIN Rail or through-hole mount for installation ease

POTENTIAL INDUSTRIAL APPLICATIONS

- Valve position
- Lifts
- Material handling
- Presses
- Conveyors
- Remote or temporary equipment
- Safety shower/eye-wash stations
- Grain diverters or gates
- Mold injection machines
- Door or gate position
- Hose attachment verification
- Specialty machines

DIFFERENTIATION

- Communicates both digital and analog node status
- Ability to produce EtherNet/IP™ and Modbus/TCP (coupler required) output

PORTFOLIO

The WMPR Series is part of the Limitless™ Series of receivers and monitors, including the [WDRR DIN Rail Receiver](#) and [WPMM Monitor](#).

Limitless™ Wireless Multi-Protocol Receiver, WMPR Series

Table 1. Specifications

	Parameter
Series name	WMPR Series
Product type	Limitless™ wireless multi-protocol receiver
Housing material	Flame retardant ABS (Acrylonitrile Butadiene Styrene)
Housing type	35 mm DIN Rail bracket or through-hole mounting plate design, 3,5 mm [#8] machine screws
Housing size	81,3 mm H x 160 mm W x 43,2 mm D [3.2 in H x 6.3 in W x 1.7 in D] ref.
Radio type	WPAN 802.15.4, 2.4 GHz
Communication agency approvals/certificates*	FCC 15.247: United States of America IC RSS 210: Canada ETSI, CE mark: European
Antenna connection/type	RP-SMA jack for direct mount or remote antenna options; omni-directional standard
Indication/operator interface	LCD display with function button navigation of a menu program Configuration LEDs: green, blue, red
Signal range	1000 ft** [305 m]** clear line of sight between Limitless™ input and receiver when using 2.2 dBi integral antenna
Supply voltage	10 Vdc to 30 Vdc
Supply current	500 mA max.
Output type	EtherNet/IP™ (ODVA - EtherNet/IP Conformance Tested™) *** Modbus™/TCP output
Output connector	RJ-45 connector
Supply connection	lever actuating connector
Reverse polarity protection	Yes
Sealing	IP20
EMC	Latest applicable standards: EN 300 328, V1.8.1; EN 61326-1 (2013); EN 301 489-1, V1.9.2; EN 301 489-17, V2.2.1
Shock	IEC 60068-2-27; half sine, 10 g, 6 mS, 3 axis
Vibration	IEC 60068-2-6; 10 Hz to 58 Hz with 0,75 mm peak-to-peak, 58 Hz to 500 Hz @ 5g
Operating temperature	-20 °C to 70 °C [-4 °F to 158 °F]

* Honeywell is continuing to add new Country Communication Agency Approvals as opportunities and requirements are established.

**Actual range will vary depending upon antennas, cables, and site topography.

*** Honeywell has tested “Modbus™ coupler” devices offered by Beckhoff Automation that will convert the WMPR’s EtherNet/IP™ output to a Modbus/TCP output. A test summary and detailed layout can be found [here](#).

Limitless™ Wireless Multi-Protocol Receiver, WMPR Series

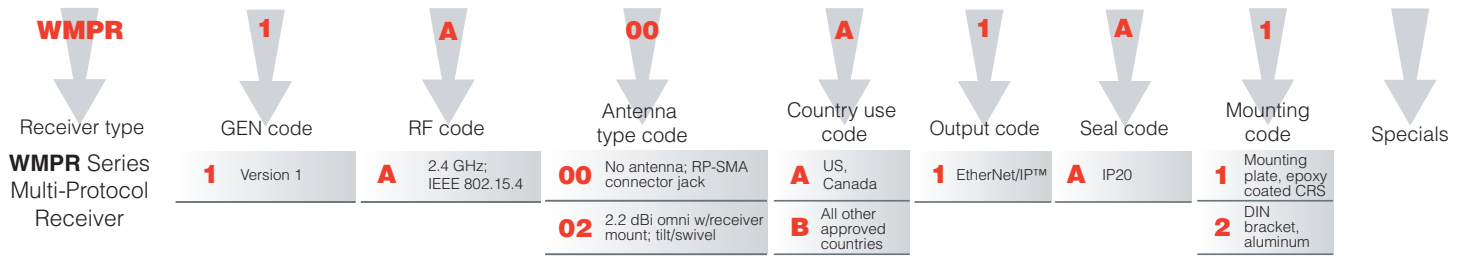
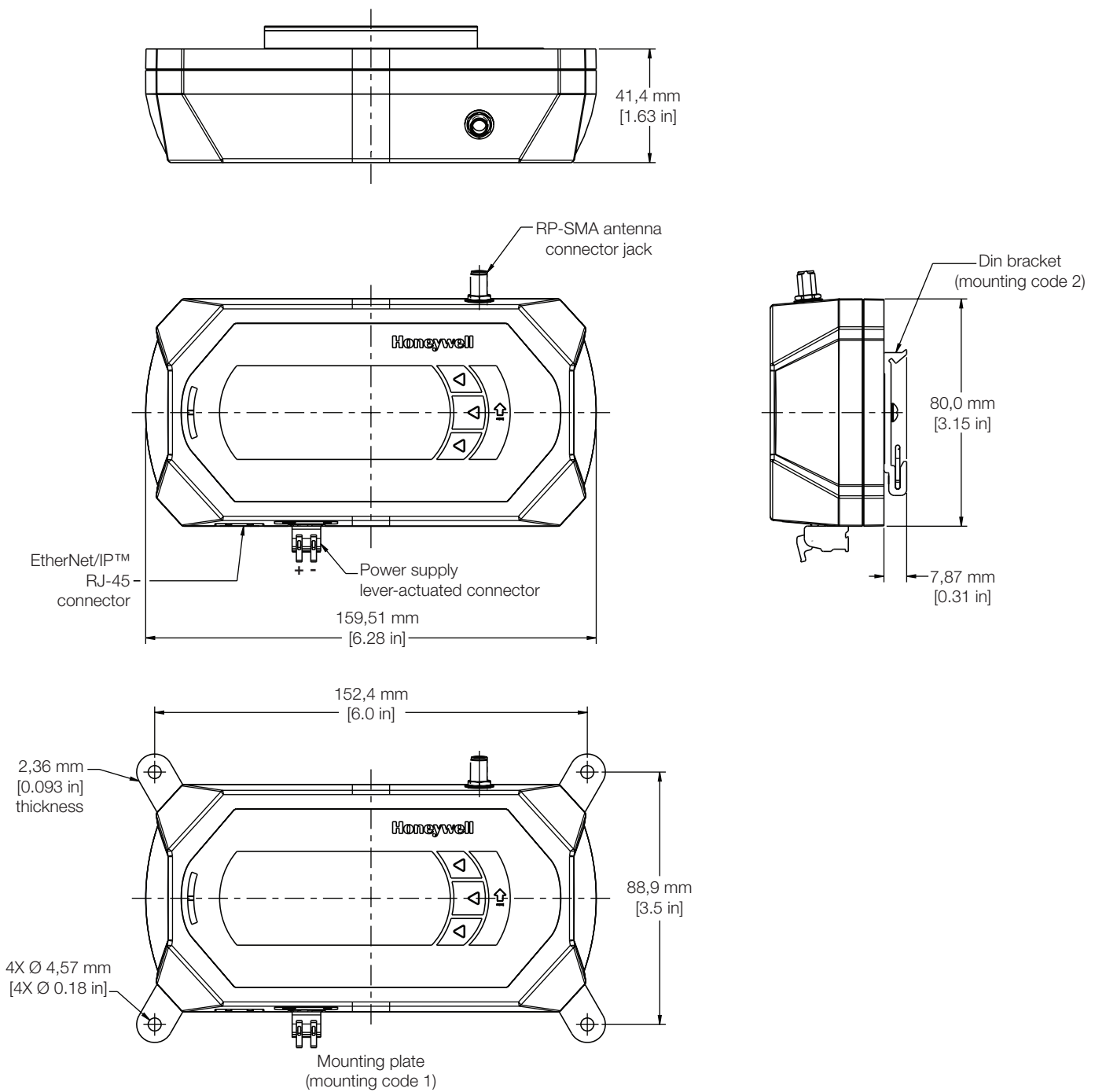

Table 2. WMPR Order Guide

Part Number	Description
WMPR1A00A1A1	Limitless™ EtherNet/IP™ output receiver, no antenna - RP-SMA jack only, mounting plate, for use in US and Canada
WMPR1A00B1A1	Limitless™ EtherNet/IP™ output receiver, no antenna - RP-SMA jack only, mounting plate, for use in all approved countries
WMPR1A00A1A2	Limitless™ EtherNet/IP™ output receiver, no antenna - RP-SMA jack only, DIN Rail bracket, for use in US and Canada
WMPR1A00B1A2	Limitless™ EtherNet/IP™ output receiver, no antenna - RP-SMA jack only, DIN Rail bracket, for use in all approved countries
WMPR1A02A1A1	Limitless™ EtherNet/IP™ output receiver, 2.2 dBi omni tilt-and-swivel antenna, mounting plate, for use in US and Canada
WMPR1A02B1A1	Limitless™ EtherNet/IP™ output receiver, 2.2 dBi omni tilt-and-swivel antenna, mounting plate, for use in all approved countries
WMPR1A02A1A2	Limitless™ EtherNet/IP™ output receiver, 2.2 dBi omni tilt-and-swivel antenna, DIN Rail bracket, for use in US and Canada
WMPR1A02B1A2	Limitless™ EtherNet/IP™ output receiver, 2.2 dBi omni tilt-and-swivel antenna, DIN Rail bracket, for use in all approved countries

Limitless™ Wireless Multi-Protocol Receiver, WMPR Series









Figure 2. Product Dimensions



Limitless™ Wireless Multi-Protocol Receiver, WMPR Series

Table 3. Antenna Listings

The WMPR Series can be ordered without an antenna by using the “00” Antenna Type Code in the part number. Antennas may be ordered separately using the part numbers below.

	Part Number (if ordered separately)	Antenna Design	Antenna Gain (dBi)	Connector/Mounting	Dimensions
	WAN01RSP	straight	2.2	RP-SMA plug/direct mount	Ø 9,91 mm x 112,78 mm L [Ø 0.39 in x 4.44 in L]
	WAN02RSP	tilt/swivel	2.2	RP-SMA plug/direct mount	Ø 9,91 mm x 112,78 mm L [Ø 0.39 in x 4.44 in L]
	WAN03RSP	flat	3.0	RP-SMA plug/adhesive mount	Ø 7,87 mm x 22,1 mm W x 4,57 mm D [Ø 0.31 in x 0.87 in W x 0.18 in D] 3 m [9 ft] cable
	WAN05RSP*	tilt/swivel	9.0	RP-SMA plug/direct mount	Ø 12,7 mm x 384,05 mm L [Ø 0.50 in x 15.12 in L]
	WAN06RNJ*	straight	8.0	RP-N jack/bracket	Ø 33,5 mm x 427,9 mm L [Ø 1.32 in x 16.85 in L]
	WAN09RSP	low profile mobile	3.0	RP-SMA plug/magnetic	Ø 76,2 mm x 115 mm L [Ø 3.0 in x 4.54 in L] 4,57 m [15 ft] cable
	WAN10RSP	straight	5.0	RP-SMA plug/magnetic	Ø 76,2 mm x 230,1 mm L [Ø 3.0 in x 9.06 in L] 1,52 m [5 ft] cable
	WAN11RSP*	low profile mobile dome	4.0	RP-SMA plug/thru-hole screw	Ø 39 mm x 42,4 mm L [Ø 1.54 in x 1.67 in L]

* Not allowed for use with Country Code “B” Limitless™ products

Limitless™ Wireless Multi-Protocol Receiver, WMPR Series

Licenses of Third Party Software

=====

This product contains software provided by third parties, which may include the below listed components. The Honeywell product that includes this file does not necessarily use all of the third party software components referred to below.

Package(s) using STMicroelectronics International license

=====

- * TIM_7PWMOutput [©Copyright 2015 STMicroelectronics International]
- * USART_HyperTerminal [©Copyright 2015 STMicroelectronics International]

License Text STMicroelectronics International

Copyright 2015 STMicroelectronics International N.V.. All rights reserved.

Redistribution and use in source and binary forms, with or without modification, are permitted, provided that the following conditions are met:

1. Redistribution of source code must retain the above copyright notice, this list of conditions and the following disclaimer.
2. Redistributions in binary form must reproduce the above copyright notice, this list of conditions and the following disclaimer in the documentation and/or other materials provided with the distribution.
3. Neither the name of STMicroelectronics nor the names of other contributors to this software may be used to endorse or promote products derived from this software without specific written permission.
4. This software, including modifications and/or derivative works of this software, must execute solely and exclusively on microcontroller or microprocessor devices manufactured by or for STMicroelectronics.
5. Redistribution and use of this software other than as permitted under this license is void and will automatically terminate your rights under this license.

THIS SOFTWARE IS PROVIDED BY STMICROELECTRONICS AND CONTRIBUTORS "AS IS" AND ANY EXPRESS, IMPLIED OR STATUTORY WARRANTIES, INCLUDING, BUT NOT LIMITED TO, THE IMPLIED WARRANTIES OF MERCHANTABILITY, FITNESS FOR A PARTICULAR PURPOSE AND NON-INFRINGEMENT OF THIRD PARTY INTELLECTUAL PROPERTY RIGHTS ARE DISCLAIMED TO THE FULLEST EXTENT PERMITTED BY LAW. IN NO EVENT SHALL STMICROELECTRONICS OR CONTRIBUTORS BE LIABLE FOR ANY DIRECT, INDIRECT, INCIDENTAL, SPECIAL, EXEMPLARY, OR CONSEQUENTIAL DAMAGES (INCLUDING, BUT NOT LIMITED TO, PROCUREMENT OF SUBSTITUTE GOODS OR SERVICES; LOSS OF USE, DATA, OR PROFITS; OR BUSINESS INTERRUPTION) HOWEVER CAUSED AND ON ANY THEORY OF LIABILITY, WHETHER IN CONTRACT, STRICT LIABILITY, OR TORT (INCLUDING NEGLIGENCE OR OTHERWISE) ARISING IN ANY WAY OUT OF THE USE OF THIS SOFTWARE, EVEN IF ADVISED OF THE POSSIBILITY OF SUCH DAMAGE.

ADDITIONAL MATERIALS

The following associated literature is available on the Honeywell web site at sensing.honeywell.com:

- Product installation instructions
- Product range guide
- Limitless™ product brochure
- Video: Dr. Larry on Limitless™ Wireless Solutions
- White Paper: Limitless™ Switches Offer Unlimited Benefits
- Technical Note: WMPR EtherNet/IP™ conversion to Modbus/TCP output
- Product application-specific information
 - Application Flyer: Fume Hood Sash Management
 - Application Flyer: Safety Shower/Eyewash Station Alarm Solutions (WBX Series)
 - Application Note: Crane Jib/Two Block Assembly
 - Application Note: Limitless™ Wireless Solutions in Anti-Two Block Warning Systems for Cranes, Stationary and on Trucks
 - Application Note: Limitless™ Wireless Solutions in Industrial Tank Level Monitoring
 - Application Note: Limitless™ Wireless Solutions on Automotive Factory Floors
 - Application Note: Limitless™ Wireless Solutions on Hangar Doors
 - Application Note: Sensors and Switches for Industrial Manual Process Valves
 - Application Note: Sensors and Switches in Mobile Cranes
 - Application Note: Sensors and Switches Used in Valve Actuators and Valve Positioners

Find out more

Honeywell serves its customers through a worldwide network of sales offices, representatives and distributors. For application assistance, current specifications, pricing or name of the nearest Authorized Distributor, contact your local sales office. To learn more about Honeywell's sensing and control products, call **+1.815.235.6847** or **1.800.537.6945**, visit **sensing.honeywell.com**, or e-mail inquiries to **info.sc@honeywell.com**

Honeywell Safety and Productivity Solutions

9680 Old Bailes Road
Fort Mill, SC 29707
www.honeywell.com

WARNING **PERSONAL INJURY**

DO NOT USE these products as safety or emergency stop devices or in any other application where failure of the product could result in personal injury.

Failure to comply with these instructions could result in death or serious injury.

WARNING **MISUSE OF DOCUMENTATION**

- The information presented in this product sheet is for reference only. Do not use this document as a product installation guide.
- Complete installation, operation, and maintenance information is provided in the instructions supplied with each product.

Failure to comply with these instructions could result in death or serious injury.

Warranty/Remedy

Honeywell warrants goods of its manufacture as being free of defective materials and faulty workmanship. Honeywell's standard product warranty applies unless agreed to otherwise by Honeywell in writing; please refer to your order acknowledgment or consult your local sales office for specific warranty details. If warranted goods are returned to Honeywell during the period of coverage, Honeywell will repair or replace, at its option, without charge those items that Honeywell, in its sole discretion, finds defective. **The foregoing is buyer's sole remedy and is in lieu of all other warranties, expressed or implied, including those of merchantability and fitness for a particular purpose. In no event shall Honeywell be liable for consequential, special, or indirect damages.**

While Honeywell may provide application assistance personally, through our literature and the Honeywell web site, it is customer's sole responsibility to determine the suitability of the product in the application.

Specifications may change without notice. The information we supply is believed to be accurate and reliable as of this printing. However, Honeywell assumes no responsibility for its use.

Honeywell

002391-3-EN IL50 GLO
August 2016

© 2015 Honeywell International Inc. All rights reserved.
EtherNet/IP™ is a registered trademark of ODVA, Inc.
EtherNet/IP Conformance Testing™ is a registered trademark of ODVA, Inc.
Modbus™ is a registered trademark of Schneider Automation Inc.