

Hall Effect Products Surface Mount Sensors

SS5 Series

FEATURES/BENEFITS

- Wide temperature and voltage ranges for design flexibility and harsh (automotive) environments.
- Temperature compensated for consistent operation with low-cost magnets (SS500).
- SS5 Package is resistant to thermal and mechanical stress.
- SS5 profile is lower than other SOT-89 packages. This allows the customer to reduce the total gap.
- Industry standard "gull-wing" design. Less susceptibility to "solder bridging". Allows increased circuit board density.
- Bipolar, unipolar and latching magnetics.
- Low Gauss versions available for high accuracy or wide gap applications.
- SS5 package allows 4-pin package designs

TYPICAL APPLICATIONS

- Brushless DC motors
- Digital current sensor
- Anti-skid braking sensor
- Piston detection in hydraulic cylinder
- Valve position sensing
- Cam, lever, shaft position sensing
- Tachometer, counter pickup
- Push-button sensor
- Disk speed, tape rotation, flow rate sensing
- Speed sensing - rate, under, over speed
- Remote reading sensor
- Magnetic card reader



SS5 Series Hall effect position sensors are operated by the magnetic field from a permanent magnet or electromagnet. The small SOT89 style package surface mounts on PC boards and flexible circuits. The SS5 uses a industry standard "gull-wing" design which makes it less susceptible to "solder bridging" and allows increased circuit board density. The SS5 series package can accommodate larger IC's than SS1 and allows for four-pin designs

The integrated circuits are designed to provide predictable performance over the full temperature range of -40 to +150°C. Bipolar, unipolar and latching magnetics are available. The SS5 has the same footprint and pin-out as the industry standard SOT-89. It will replace Honeywell SS1 Series and any equivalent SOT-89 sensors from other suppliers with minimum or no design changes.

On-board regulation provides extremely stable operation over the full supply voltage range of 4.5 to 24 VDC(SS51T) or 3.8 to 30 VDC(SS500). Current consumption is a low 10 mA maximum at 40°C and is typically 7mA or less at room temperature and above. SS5 sensors are capable of continuous 20 mA sinking output, and can withstand temporary current as high as 20 mA maximum (SS51T) or 50 mA maximum (SS500). They can use existing power supply sources in most applications, and can be directly interfaced with many electronic components without buffering or compensation circuitry.

SS5 Series sensors are supplied on tape and reel for high-volume, automated pick and place equipment. Each reel contains 1,000 sensors.

MICRO SWITCH supplies bar and ring magnets for operating Hall effect sensors. Bar magnets can operate any Hall effect sensor. Ring magnets are magnetized on the outside diameter with alternating North and South poles. They are particularly useful with bipolar sensors and rpm measurement.

Hall Effect Products

Surface Mount Sensors

SS5 Series

WIRING DIAGRAMS

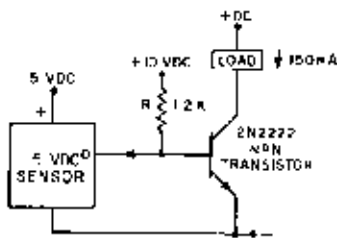
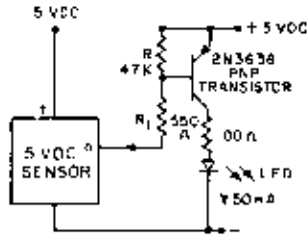
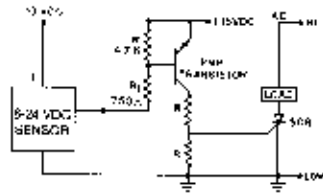

ABSOLUTE MAXIMUM RATINGS

Catalog Listing	SS51T	SS500
Supply Voltage	-28 to +28 VDC	-1 to +30 VDC
Voltage externally applied to output	+28 VDC max. (OFF condition only) -0.5 VDC min. (OFF or ON condition)	+30 VDC max. (OFF condition only)
Output ON Current	20 mA max.	50 mA max.
Temperature Limits		
Operating	-40 to +150°C (-40 to +302°F)	-50 to +160°C (-46 to +320°F)
Storage	-40 to +150°C (-40 to +302°F)	-65 to +160°C (-54 to +320°F)
Magnetic Flux	No limit. Circuit cannot be damaged by magnetic overdrive.	No limit. Circuit cannot be damaged by magnetic overdrive.

Stresses greater than those listed under "Absolute Maximum Ratings" may cause permanent damage to the device. This is a stress rating only and functional operation of the device at these or any other conditions above those indicated in the operations section for extended periods of time may affect reliability.

OPERATING CHARACTERISTICS

	SS51T	SS500	Remarks
Supply Voltage	4.5 to 24 VDC	3.8 to 30 VDC	
Current Consumption (I _{off})	10 mA	10 mA	Max over temp
Output Voltage (operated)	0.4 V	0.4 V	Sinking 20 mA max.
Output Current (operated)	20 mA	20mA	
Output Leakage Current	10 μA	10μA	
Output Switching Time			V _{CC} = 12 V,
Rise, 10 to 90%	1.5 μs	1.5 μs	R _L = 1.6 K Ohm,
Fall, 90 to 10%	1.5 μs	1.5 μs	C _L = 20 pF
Operating Temperature; °C	-40 to +150°C	-40 to +150°C	

Hall Effect Products

Surface Mount Sensors

SS5 Series

MAGNETIC CHARACTERISTICS

Catalog Listing	SS51T	SS511AT	SS513AT	SS541AT	SS543AT	SS549AT	SS561AT	SS566AT	
Magnetic Type	Bipolar	Bipolar	Bipolar	Unipolar	Unipolar	Unipolar	Latching	Latching	
Magnetic Characteristics (Gauss)									
-40°C	Max. Op.	145	70	140	135	215	440	110	200
	Min. Rel.	-145	-70	-140	20	80	210	-110	-200
	Min. Dif.	40	15	20	15	25	30	50	200
0°C	Max. Op.	145	65	140	117	190	400	90	185
	Min. Rel.	-145	-65	-140	20	80	230	-90	-185
	Min. Dif.	50	15	20	18	25	30	50	200
25°C	Max. Op.	140	60	140	115	180	390	85	180
	Min. Rel.	-140	-60	-140	20	75	235	-85	-180
	Min. Dif.	50	15	20	20	25	30	50	200
85°C	Max. Op.	150	60	140	120	180	400	85	180
	Min. Rel.	-150	-60	-140	15	70	215	-85	-180
	Min. Dif.	50	12	20	15	15	30	50	190
125°C	Max. Op.	200	65	140	123	190	410	100	180
	Min. Rel.	-200	-65	-140	15	60	200	-100	-180
	Min. Dif.	60	12	20	8	10	30	50	160
150°C	Max. Op.	250	70	140	125	200	420	110	185
	Min. Rel.	-250	-70	-140	10	55	185	-110	-185
	Min. Dif.	NS	10	20	5	5	30	50	140

OPERATE AND RELEASE POINTS

SS51T

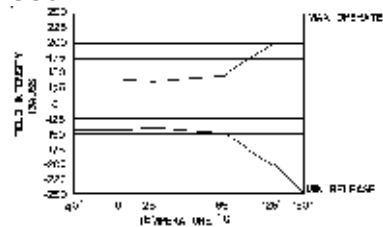

SS511AT

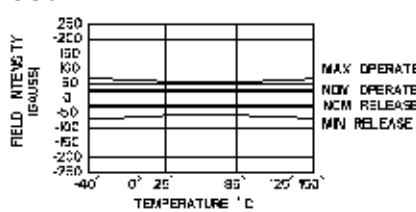

SS513AT

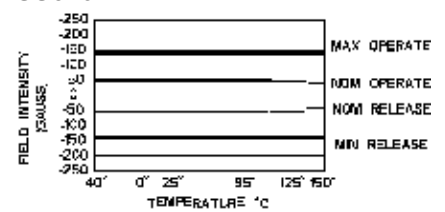

SS541AT

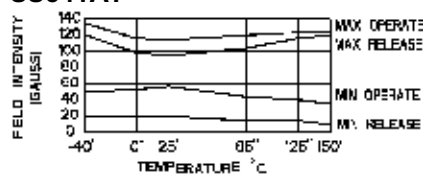

SS543AT

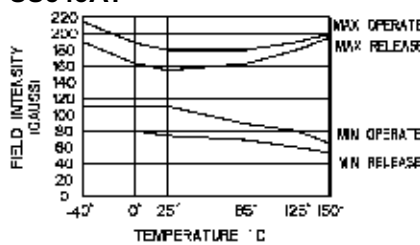

SS549AT

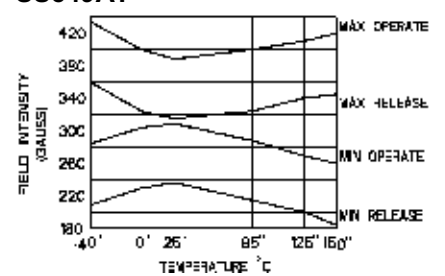

SS561AT

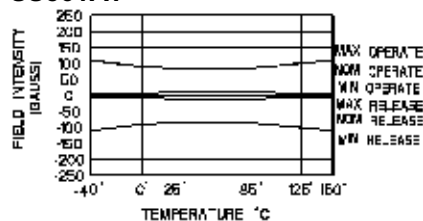

SS566AT

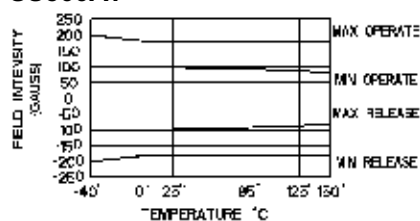

Hall Effect Products

Surface Mount Sensors

SS5 Series

WARRANTY/REMEDY

Honeywell warrants goods of its manufacture as being free of defective materials and faulty workmanship. Contact your local sales office for warranty information. If warranted goods are returned to Honeywell during the period of coverage, Honeywell will repair or replace without charge those items it finds defective. The foregoing is Buyer's sole remedy and is **in lieu of all other warranties, expressed or implied, including those of merchantability and fitness for a particular purpose.**

Specifications may change without notice. The information we supply is believed to be accurate and reliable as of this printing. However, we assume no responsibility for its use.

While we provide application assistance personally, through our literature and the Honeywell web site, it is up to the customer to determine the suitability of the product in the application.

For application assistance, current specifications, pricing or name of the nearest Authorized Distributor, contact a nearby sales office. Or call:

1-800-537-6945 USA
 1-800-737-3360 Canada
 1-815-235-6847 International

FAX

1-815-235-6545 USA

INTERNET

www.honeywell.com/sensing
info@micro.honeywell.com

MOUNTING DIMENSIONS

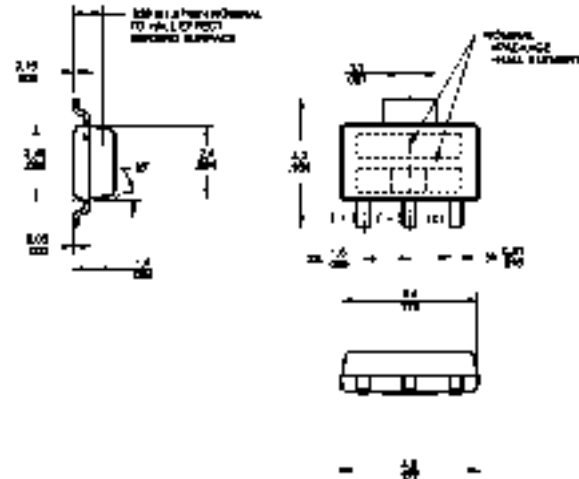

TAPE DIMENSIONS

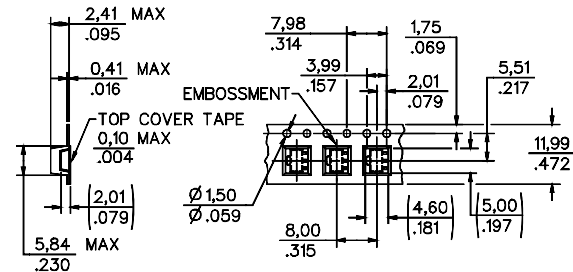

REEL DIMENSIONS

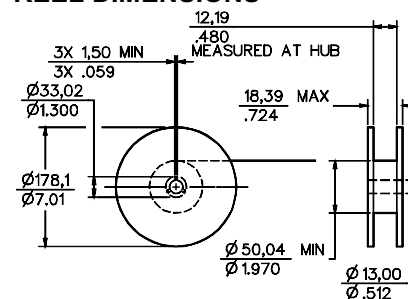

Honeywell

Sensing and Control
 Honeywell Inc.
 11 West Spring Street
 Freeport, Illinois 61032

www.honeywell.com/sensing