

Limit and Enclosed Switches

LD Series

Multiple Plunger Limit Switches

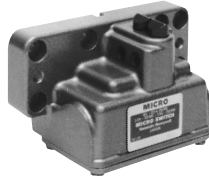

FEATURES

- Ideal source of replacement parts for imported machine tools or transplant factories
- Up to 15A capacity
- Variety of switch units
- Roller and chisel plunger are available
- Operating points are precisely factory-adjusted
- Easy mounting and wiring
- NEMA 6, 13 and IEC IP 67 sealing
- Temperature range -10 to +70°C (+14 to +158°F)

One LD series multi-plunger limit switch can replace several individual switches in many machine tooling applications, and on welding and transfer machines in automobile plants.

Numerous conduit arrangements are possible, making switch wiring and maintenance simple and inexpensive.

Catalog Listing	LDS-5000K Series	LDV-5000 Series	LDZ-5000 Series	LD-Z Series	
Electrical Specifications 	Max. current at max. voltage ratings	10A at 125, 250VAC	15A at 125, 250, 480VAC	15A at 125, 250, 480VAC	
Single Pole Double Throw	Circuitry	SPDT	SPDT	SPDT	
Operating Characteristics	Plunger Number	2,3,4,5,6,7,8	2,3,4,6,8	2,3,4,6,8,10,12	2
	Pitch	8 ± 0.15mm	12 ± 0.2mm	19 ± 0.2mm	18 ± 0.25mm
	Type	Chisel-shaped	Chisel-shaped roller	Chisel-shaped roller	Roller
	O.F. max. - N/lb.	10/2.2	14.74/3.3	19.75/4.4	14.74/3.3
	P.T. max. - mm/in.	1.5/0.06	1.5/0.06	1.5/0.06	1.5/0.06
	O.T. min. - mm/in.	2/0.99	3/0.12	3/0.12	3/0.12
	D.T. - mm/in.	0.2/0.008 max.	0.1-0.32 0.004-0.013	0.01-0.05 0.0005-0.002	0.01-0.05 0.0005-0.002

Characteristics: O.F.—Operating Force; P.T.—Pretravel; O.T.—Overtravel; D.T.—Differential Travel; N—Newtons

ORDER GUIDE

(For identification of existing listings only. Not for generating new listings.)

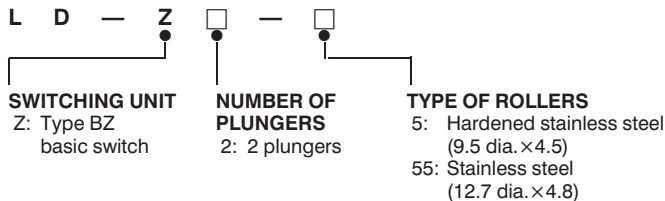
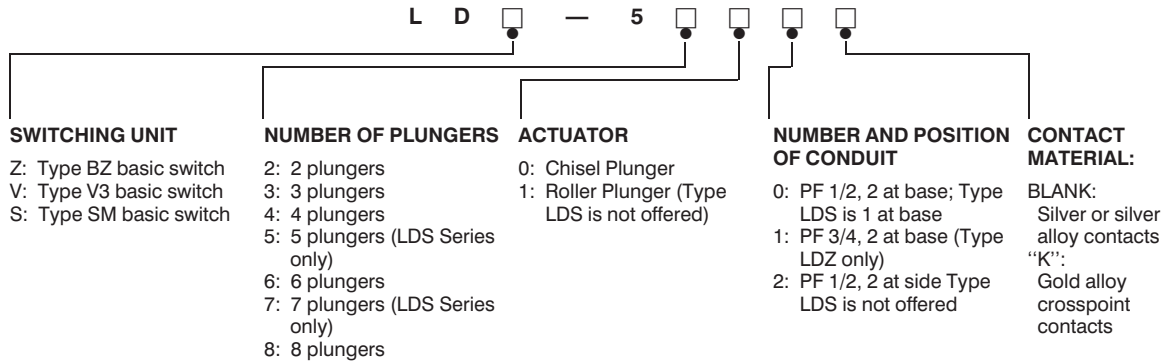

REPLACEMENT SWITCH UNITS

Switches	Replacement
LDS-5000	AS-J212
LDS-5000K	AS-J212K
LDZ-5000	AS-J209
LDZ-5000K	AS-J209K
LDV-5000	AS-J215
LDV-5000K	AS-J215K
REPLACEMENT HEADS - LDZ ONLY	
Bevel	9PA-J68
Roller	9PA-J67

Limit and Enclosed Switches

LD Series

Multiple Plunger Limit Switches

MOUNTING DIMENSIONS $\frac{0.0 \text{ mm}}{0.00 \text{ inches}}$
(For reference only)

LDS-5000 and LDS-5000K

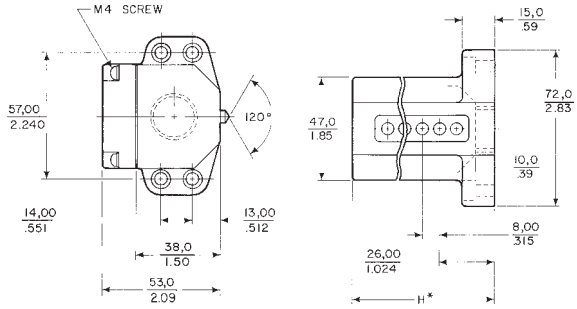

*NUMBER OF PLUNGERS 2 4 6 8
DIMENSION "H" 50 mm 66 mm 82 mm 98 mm

LDZ-5000

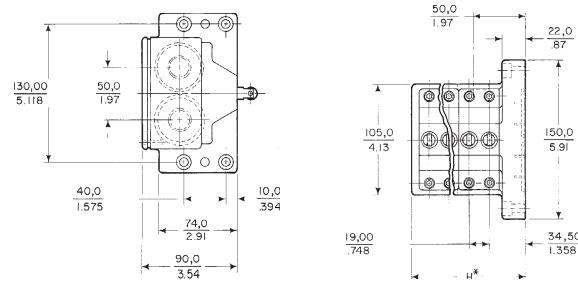

*NUMBER OF PLUNGERS 2 4 6 8
DIMENSION "H" 70 mm 108 mm 146 mm 184 mm

Limit/Enclosed

LD-Z

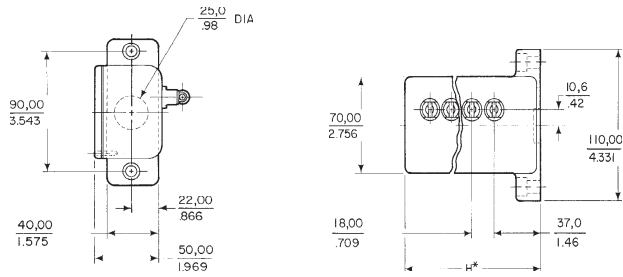

*NUMBER OF PLUNGERS 2 4 6
DIMENSION "H" 75 mm 110 mm 145 mm

LDV-5000

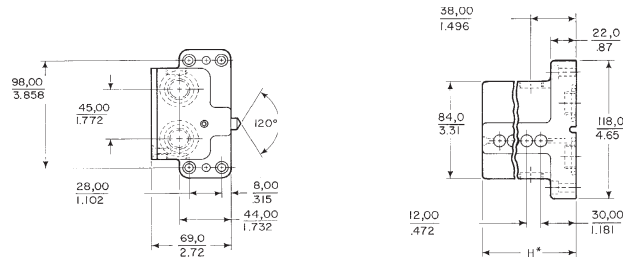

*NUMBER OF PLUNGERS 2 3 4 6
DIMENSION "H" 58 mm 70 mm 82 mm 106 mm